

JIS

JAPANESE
INDUSTRIAL
STANDARD

Translated and Published by
Japanese Standards Association

Ⓕ JIS B 2220 : 2004

(JPF/JSA)

Steel pipe flanges



2004年6月28日
2005年4月12日

ICS 23.040.60 ; 77.140.99

Reference number : JIS B 2220 : 2004 (E)

PROTECTED BY COPYRIGHT

Foreword

This translation has been made based on the original Japanese Industrial Standard revised by the Minister of Economy, Trade and Industry through deliberations at the Japanese Industrial Standards Committee, as the result of proposal for revision of Japanese Industrial Standard submitted by the Japan Pipe Fittings Association (JPF)/the Japanese Standards Association (JSA) with the draft being attached, based on the provision of Article 12 Clause 1 of the Industrial Standardization Law applicable to the case of revision by the provision of Article 14:

Currently, to revise the International Standard of steel pipe flanges (ISO 7005-1:1992), the International Organization for Standardization (ISO) has started with its deliberation. In the process of the deliberation, the Organization intends to issue the standard as a new one through deviding the relevant International Standard into the European type, the United States type, and the Japanese type, with each of them being set at the part organization (part system).

In Europe, a draft for submission based on the EN Standard is beig arranged, and in the United States, based on the ASME Standard.

This Standard has been prepared through the integration of the existing JIS B 2220:2001 *Steel welding pipe flanges* and JIS B 2238:1996 *General rules for steel pipe flanges* for arrangement as a draft for submission from Japan.

By the result, this standard shall be replaced, revising JIS B 2220:2001 and withdrawing JIS B 2238:1996.

Attention is drawn to the possibility that some of the elements of this Standard may conflict with a patent right, application for a patent after opening to the public, utility model right or application for registration of utility model after opening to the public which have technical properties. The relevant Minister and the Japanese Industrial Standrds Committee are not responsible for identifying the patent right, application for a patent after opening to the public, utility model right or application for registration of utility model after opening to the public which have the said technical properties.

Date of Establishment: 1984-10-1

Date of Revision: 2004-01-20

Date of Public Notice in Official Gazette: 2004-01-20

Investigated by: Japanese Industrial Standards Committee
Standards Board
Technical Committee on Machine Elements

JIS B 2220 : 2004, First English edition published in 2004-05

Translated and published by: Japanese Standards Association
4-1-24, Akasaka, Minato-ku, Tokyo, 107-8440 JAPAN

In the event of any doubts arising as to the contents,
the original JIS is to be the final authority.

© JSA 2004

All rights reserved. Unless otherwise specified, no part of this publication may be reproduced or utilized in any form or by any means, electronic or mechanical, including photocopying and microfilm, without permission in writing from the publisher.

Printed in Japan

M&T

PROTECTED BY COPYRIGHT

Contents

	Page
Introduction	1
1 Scope	1
2 Normative references	2
3 Definitions	3
4 Classification of flange and their designations	3
5 Classification of gasket faces and their designations	5
6 Designation of flanges according to zinc plating	7
7 Materials	7
8 Relationship between fluid temperature and maximum working pressure	9
9 Nominal size of flange and application of pressure-temperature rating	9
10 Dimensions	9
10.1 Dimensions of gasket face	9
10.2 Dimensions of flanges	9
10.3 Thread	10
10.4 Dimensional tolerance	10
11 Appearance	10
12 Surface finishing	10
12.1 Gasket face	10
12.2 Welded portions	11
12.3 Facing subjected to hot-dip zinc coating	11
13 Soundness	11
13.1 Liquid penetrant testing and magnetic particle testing	11
13.2 Ultrasonic flaw detection	11
14 Zinc coating	11

15	Manufacturing method	11
15.1	Flange	11
15.2	Zinc coating	12
16	Test methods	12
16.1	Liquid penetrant testing	12
16.2	Magnetic particle testing	12
16.3	Ultrasonic testing	12
16.4	Cupric sulfate test	12
17	Inspection	12
17.1	Inspection for shape and dimensions	12
17.2	Appearance inspection	12
17.3	Surface finish inspection	12
17.4	Inspection by liquid penetrant testing	12
17.5	Inspection by magnetic particle testing	12
17.6	Inspection by ultrasonic testing	13
17.7	Hot-dip zinc coating inspection	13
17.8	Material inspection	13
17.9	Acceptance inspection	13
18	Designation	13
19	Marking	14
Annex 1 (normative)	Flanges processed by flash butt welding	37
Annex 2 (informative)	Outside diameter of steel pipes	39
Annex 3 (informative)	Standards of ASTM materials and ISO materials	40
Annex 4 (informative)	Small raised faces	42
Annex 5 (informative)	Details of welded portion of welding flanges	43
Annex 6 (informative)	Flanges of nominal pressure 2K, 40K and 63K	47
Annex 7 (informative)	Calculated mass of flanges	50
Annex 8 (informative)	Table of relationship between JIS and corresponding international standards	52

Steel pipe flanges

Introduction This Japanese Industrial Standard has been prepared based on ISO 7005-1 *Metallic flanges—Part 1 : Steel flanges* published in 1992 as the first edition with some modifications of the technical contents. A list of modifications with the explanations is given in annex 8 (informative).

1 Scope This Standard specifies steel pipe flanges (hereafter referred to as “flanges”) of nominal size 10A to 1500A for nominal pressure 5K, 10K, 10K light type, 16K, 20K and 30K which are used to join parts for piping, such as steel pipes and valves, in ordinary ⁽¹⁾, pressure ⁽²⁾, high pressure ⁽³⁾, high temperature ⁽⁴⁾, alloy steel pipes ⁽⁵⁾, stainless steel pipes ⁽⁶⁾ piping for steam, air, gas, water, oil, etc. ⁽⁷⁾.

Notes ⁽¹⁾ Piping using Carbon steel pipes for ordinary piping of JIS G 3452 and arc welded carbon steel pipes of JIS G 3457.

⁽²⁾ Piping using Carbon steel pipes for pressure service of JIS G 3454.

⁽³⁾ Piping using Carbon steel pipes for high pressure service of JIS G 3455.

⁽⁴⁾ Piping using Carbon steel pipes for high temperature service of JIS G 3456.

⁽⁵⁾ Piping using Alloy steel pipes of JIS G 3458.

⁽⁶⁾ Piping using stainless steel pipes of JIS G 3459 and large diameter welded stainless steel pipes of JIS G 3468.

⁽⁷⁾ Integral flange, which is to be used as part of some other equipment or components, shall also be within the scope of this Standard.

Remarks 1 The International Standard corresponding to this Standard is as follows.

In addition, symbols which denote the degree of correspondence in the contents between the relevant International Standard and JIS are IDT (identical), MOD (modified), and NEQ (not equivalent) according to ISO/IEC Guide 21.

ISO 7005-1 : 1992 *Metallic flanges—Part 1 : Steel flanges* (NEQ)

2 The outside diameters of JIS steel pipes are shown in annex 2 (informative).

3 The pressure used in this Standard indicates gage pressure.

2 Normative references The following standards contain provisions which, through reference in this Standard, constitute provisions of this Standard. The most recent editions of the standards (including amendments) indicated below shall be applied.

- JIS B 0151 *Iron and steel pipe fittings—Vocabulary*
- JIS B 0203 *Taper pipe threads*
- JIS B 0601 *Geometrical Product Specification (GPS)—Surface texture: Profile method—Terms, definitions and surface texture parameters*
- Remarks : ISO 4287:1997 *Geometrical Product Specifications(GPS)—Surface texture : Profile method—Terms, and definitions and surface texture parameters* is identical with the said standard.
- JIS B 0621 *Definitions and designations of geometrical deviations*
- JIS G 0303 *General rules for inspection of steel*
- JIS G 0565 *Method for magnetic particle testing of ferromagnetic materials and classification of magnetic particle indication*
- JIS G 3101 *Rolled steels for general structure*
- JIS G 3201 *Carbon steel forgings for general use*
- JIS G 3202 *Carbon steel forgings for pressure vessels*
- JIS G 3203 *Alloy steel forgings for pressure vessels for high-temperature service*
- JIS G 3214 *Stainless steel forgings for pressure vessels*
- JIS G 3452 *Carbon steel pipes for ordinary piping*
- JIS G 3454 *Carbon steel pipes for pressure service*
- JIS G 3455 *Carbon steel pipes for high pressure service*
- JIS G 3456 *Carbon steel pipes for high temperature service*
- JIS G 3457 *Arc welded carbon steel pipes*
- JIS G 3458 *Alloy steel pipes*
- JIS G 3459 *Stainless steel pipes*
- JIS G 3468 *Large diameter welded stainless steel pipes*
- JIS G 4051 *Carbon steels for machine structural use*
- JIS G 4304 *Hot rolled stainless steel plates, sheets and strip*
- JIS G 4305 *Cold rolled stainless steel plates, sheets and strip*
- JIS G 5101 *Carbon steel castings*
- JIS G 5121 *Corrosion-resistant cast steels for general applications*
- JIS G 5151 *Steel castings for high temperature and high pressure service*
- JIS H 0401 *Methods of test for hot dip galvanized coatings*
- JIS H 2107 *Zinc ingots*
- JIS H 8610 *Electroplated coatings of zinc on iron or steel*

JIS Z 2241 *Method of tensile test for metallic materials*

JIS Z 2343-1 *Non-destructive testing—Penetrant testing—Part 1 : General principles—
Method for liquid penetrant testing and classification of the penetrant indication*

JIS Z 3001 *Welding terms*

JIS Z 3121 *Methods of tensile test for butt welded joints*

JIS Z 3122 *Methods of bend test for butt welded joint*

3 Definitions For the purposes of this Standard, the definitions of the principal terms given in JIS B 0151 and JIS Z 3001 apply.

4 Classification of flanges and their designations Flanges and their designations shall be classified according to their shapes as shown in table 1.

The types of slip-on hubbed flanges (SOH) for nominal pressure 20K and 30K shall be as described in table 2.

Table 1 Classification of flanges and the designation





Classification of flange		Designation	Figure
Welding flange	Slip-on plate flange	SOP	
	Slip-on hubbed flange	SOH	
	Socket welding flange	SW	
	Welding neck flange	WN	
Lap joint flange		LJ	
Threaded flange		TR	

Table 1 (concluded)

Classification of flange	Designation	Figure
Integral flange	IT	
Blank flange	BL	

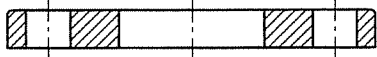
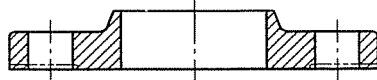
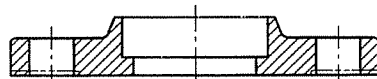
Table 2 Types of nominal pressure 20 K and 30 K slip-on hubbed flanges (SOH)

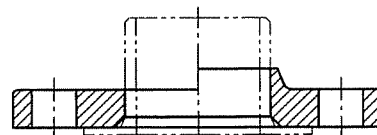
Classification of flange	Type	Figure
Slip-on hubbed flange	Type A	
	Type B	
	Type C	

5 Classification of gasket faces and their designations Gasket faces and their designations shall be as shown in table 3. Male-female face gasket (MF) indicates a combination of male seat (MF·M) and female seat (MF·F) and tongue and groove (TG) indicates a combination of tongue seat (TG·T) and groove seat (TG·G).

Table 3 Classification of gasket face and the designation

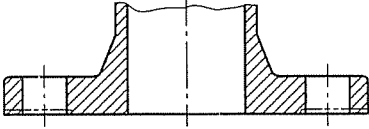
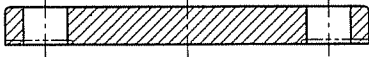
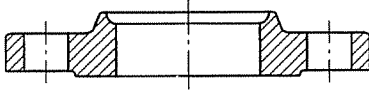
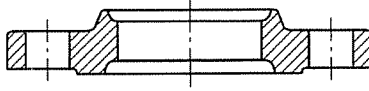
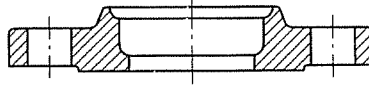
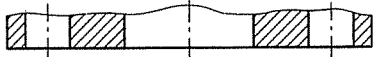
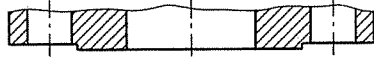
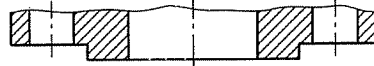
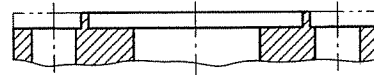
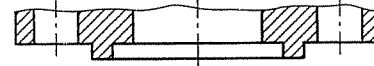
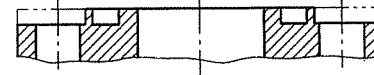
Classification of gasket face		designation		Figure
Full face		FF		
Raised face		RF		
Male-female face	Male seat	MF	MF-M	
	Female seat		MF-F	
Tongue and groove	Tongue	TG	TG-T	
	Groove		TG-G	

6 Designation of flanges according to zinc coating Designation according to the presence of zinc coating shall be as given in table 4.

Table 4 Designation according to the presence of zinc coating

Designation	Definitions
Black flange	Flanges not subjected to zinc coating
White flange (ZN)	Flanges subjected to hot dip zinc coating or electroplated zinc coating

7 Materials Materials of the flanges shall be the ones given in table 5 or those at least equivalent to them in both the mechanical properties and corrosion resistance. Materials of welding flanges shall be suitable for welding.

Remarks : ASTM materials and ISO materials admitted that they are equivalent or superior to the materials given in table 5 are shown in reference table 1 and reference table 2, respectively.

Table 5 Materials

Material	Rolled steels		Steel forgings		Steel castings		Material group No.
	Number of standard	Symbol of material	Number of standard	Symbol of material	Number of standard	Symbol of material	
Carbon steel	JIS G 3101	SS 400	JIS G 3201	SF 390A	JIS G 5101	SC 410	001
	JIS G 4051	S 20 C	JIS G 3202	SFVC 1	JIS G 5151	SCPH 1	
	JIS G 4051	S 25 C	JIS G 3201	SF 440A	JIS G 5101	SC 480	002
	—	—	JIS G 3202	SFVC 2A	JIS G 5151	SCPH 2	003a
Low alloy steel	—	—	JIS G 3203	SFVA F1	JIS G 5151	SCPH 11	013a
	—	—	JIS G 3203	SFVA F11A	JIS G 5151	SCPH 21	015a
Stainless steel	JIS G 4304	SUS 304	JIS G 3214	SUS F304	JIS G 5121	SCS 13A	021a
	JIS G 4305	SUS 304				SCS 19A	
	—	—	—	—	JIS G 5121	SCS 14A	021b
	JIS G 4304	SUS 316	JIS G 3214	SUS F316	JIS G 5121	SCS 16A	022a
	JIS G 4305	SUS 316				SCS 19A	
	—	—	—	—	JIS G 5121	SCS 16A	022b
	JIS G 4304	SUS304L	JIS G 3214	SUS F304L	—	—	023a
	JIS G 4305	SUS304L				—	
JIS G 4304	SUS316L	JIS G 3214	SUS F316L	—	—	023b	
JIS G 4305	SUS316L				—		

Remarks 1 SS 400 of JIS G 3101 and SF 390A and SF 440A of JIS G 3201 shall be those which have a carbon content of 0.35 or less.

2 The inspection of S20C and S25C of JIS G 4051 shall be conducted as specified in JIS G 0303, and the tensile strength of S20C shall be 400 N/mm² or greater and S25C, 440 N/mm² or greater.

Reference Table 1 ASTM materials

Material	Rolled steels		Steel forgings		Steel castings		Material group Number
	Number of standard	Symbol of material	Number of standard	Symbol of material	Number of standard	Symbol of material	
Carbon steel	A 515	70	A 105	—	A 216	WCB	1.1
	A 516	70	A 350	LF2			
	A 537	CL1					
Low alloy steel	A 204	A	A 182	F1	A 217	WC1	1.5
	A 204	B			A 352	LC1	
	A 387	11 CL2	A 182	F11 CL2	A 217	WC6	1.9
Stainless steel	A 240	304	A 182	F304	A 351	CF3	2.1
	A 240	304H	A 182	F304H	A 351	CF8	
	A 240	316	A 182	F316	A 351	CF3M	2.2
	A 240	316H	A 182	F316H	A 351	CF8M	
	A 240	317			A 351	CG8M	
	A 240	304L	A 182	F304L	—	—	2.3
	A 240	316L	A 182	F316L			

Remarks : For standards shown here, see annex 3 (informative)

Reference Table 2 ISO materials

Unit : mm

Material	Rolled steels			Steel forgings			Steel castings		Material group No.		
	Number of standard	Symbol of material	Thickness	Number of standard	Symbol of material	Thickness	Number of standard	Symbol of material			
Carbon steel	ISO 9328-2	PH 290	60 or less	ISO 2604-1	F13	63 or less	ISO 4991	C26-52H	1.1		
		PH 315	over 60 to and incl. 100		F18	over 63 to and incl. 250					
		PH 355			F72	63 or less					
Low alloy Steel	ISO 9328-2	16 Mo 3	60 or less	ISO 2604-1	F 28	—	ISO 4991	C28H	1.5		
	—	—	—	—	—	—	ISO 4991	C32H	1.9		
Stainless steel	ISO 9328-5	X 5 CrNi 18 9	—	ISO 2604-1	F49	—	ISO 4991	C46	2.1		
					C47						
	ISO 9328-5	X 5 CrNiMo 17 12	—	ISO 2604-1	F62	—	ISO 4991	C57	2.2		
					F64	—		C60			
					C61						
	ISO 9328-5	X 2 CrNiMo 17 12	—	ISO 2604-1				C61LC			
					X 2 CrNi 18 10	—	ISO 2604-1	F46	—	—	—
F59								—			
X 2 CrNiMo 17 13	—										

Remarks : For standards shown here, see annex 3 (informative)

8 Relationship between fluid temperature and maximum working pressure Relationship between fluid temperature and maximum working pressure (hereafter referred to as “pressure-temperature rating”) shall be as given in table 1. While the light flange of nominal pressure 10K shall generally be used for steady flow at a temperature of 120 °C or less and a pressure of 0.7 MPa or less.

The working temperature for white flanges shall be maximum 300 °C.

9 Nominal size of flange and application of pressure-temperature rating The application of the pressure-temperature rating to the nominal size of flanges, each type and nominal size of flanges shall be as given in attached table 2. However, the nominal size of light flange for nominal pressure 10K shall be as given in table 6 regardless of its temperature-pressure rating.

Table 6 Nominal size of light flanges for nominal pressure 10K

Nominal pressure	Type of flanges	Nominal size A																			
		10	15	20	25	32	40	50	65	80	90	100	125	150	175	200	225	250	300	350	400
10K light type	SOP	○	○	○	○	○	○	○	○	○	○	○	○	○	○	○	○	○	○	○	○
	SOH	-	-	-	-	-	-	-	-	-	-	-	-	-	-	-	-	-	-	-	○

10 Dimensions

10.1 Dimensions of gasket faces The dimensions of gasket faces of the flange shall be as described in attached table 3.

Remarks : The dimensions of the small raised face are shown in annex 4 (informative).

10.2 Dimensions of flanges The dimensions of flanges for each nominal pressure shall be as given in attached tables 4 to 9.

- Remarks 1 Inside diameter of the integral flange (IT) (*d*) and the diameter of hub (*b*) and the radius of fillet (*r*) given in attached table 4, attached table 5, and attached tables 7 to 9 are given for reference. Inside diameter (*d*) complies with JIS B 2001. In the case of other dimensions, the strength of the flange shall be calculated.
- 2 For slip-on welding flange (plate flange) (SOP) for nominal pressure 5K and blank flange (BL) of nominal size 400A or larger given in attached table 4, slip-on plate flange (SOP) for nominal pressure 10K, and blank flange (BL) of nominal size 250A or larger given in attached table 5, full face gaskets should be used instead of ring gasket so as to prevent flanges from being applied excessive bending moment.
- 3 The details of welded portion of welding flange are shown in annex 5 (informative).

- 4 The pressure-temperature rating and basic dimensions of flanges of nominal pressure 2 K, 40 K and 63 K are shown in annex 5 (informative).
- 5 The calculated mass of the flange is shown in annex 7 (informative).

10.3 Thread The thread of threaded flange (TR) shall be described in JIS B 0203.

10.4 Dimensional tolerance The dimensional tolerance on flanges shall be as specified in attached table 10. Each axis line of socket of flange, socket of slip-on flange (SOP and SOH), and the socket of socket welding flange (SW) shall be perpendicular to the gasket face enough for practical use.

Perpendicularity to the gasket face of the axis line of the thread of threaded flange (TR) shall be within 0.9 mm per 100 mm of the axis line. Perpendicularity shall be as described in 5.8 of JIS B 0621.

The axis line of the thread of threaded flange (TR) shall be perpendicular to the gasket face within tolerance of 0.5° .

11 Appearance The flanges shall be free from any cracks or flaws detrimental to use.

12 Surface finishing

12.1 Gasket faces The gasket faces of the flanges shall be finished in accordance with table 7. Gasket faces of full face (FF), raised face (RF), and male-female face (MF) shall be finished by turning with a round-end tool. The turning condition for 3.2 μm and 6.3 μm *Ra* shall be as described in table 8.

The gasket face may be finished otherwise under an agreement between the parties concerned.

Table 7 Finishing on gasket face

Unit : μm

Gasket face	<i>Ra</i>
Full face (FF)	3.2 to 6.3
Raised face (RF)	3.2 to 6.3
Male-female face (MF) (Male seat and female seat)	3.2 or less
Tongue and groove (TG) (Tongue seat and groove seat)	3.2 or less

Remarks : The value of *Ra* depends on the definitions of JIS B 0601.

Table 8 Turning condition for gasket face

<i>Ra</i> μm	Turning condition	
	Radius of blade edge mm	Pitch of serration mm
3.2	0.8	0.25 to 0.30
	1.6	0.35 to 0.42
6.3	0.8	0.35 to 0.42
	1.6	0.52 to 0.60

12.2 **Welded portion** Welded portion of welding flange with steel pipe shall be appropriately machined.

12.3 **Facing subjected to hot-dip zinc coating** The inside diameter surface of flanges subjected to hot-dip zinc coating [excluding the smaller inside diameter of socket welding flanges (SW) and the inside diameter of welding neck flanges (WN)] may be of grinded or machined to remove the coating as required.

13 Soundness

13.1 **Liquid penetrant testing and magnetic particle testing** Cast steel flanges shall satisfy the requirements for the soundness by means of liquid penetrant testing and magnetic particle testing specified in standards for individual steel castings.

13.2 **Ultrasonic flaw detection** Forged steel or cast steel flanges shall satisfy the requirements for the soundness by means of ultrasonic testing specified in standards for individual steel forgings or steel castings.

14 **Zinc coating** Zinc coating shall be made as given in the following.

- a) Flanges subjected to hot-dip zinc coating shall not attain the final point in a cupric sulphate test even when the immersion is carried out for 5 cycles.
- b) The electroplated zinc coating shall be grade 2 of JIS H 8610 or at least equivalent thereto in corrosion resistance.

15 Manufacturing method

15.1 **Flange** Flanges shall be manufactured through the necessary machinings after forging by the following method a), or after casting by b).

The plate flange (SOP and LJ without hub) may be manufactured through the necessary machining after forming by c) or d).

Blank flange (BL) may be manufactured through the necessary machinings after forming by c).

- a) To be hot-forged from a steel ingot or billet. In this case, a heat treatment specified in the corresponding standards for the individual forgings shall be applied.
- b) To be cast using appropriate melting and casting equipment. In this case, a heat treatment specified in the corresponding standards for the individual castings shall be applied.

- c) To be manufactured from a steel sheet by press-work punching, gas cutting, plasma arc cutting, etc. Where the gas or plasma arc cutting is applied, the cut surface of the flange shall be eliminated at least 2 mm by machining.
- d) To be processed with flash welding as specified in annex 1 (normative).

15.2 Zinc coating When applying zinc coating to the flange, the following shall be applied.

- a) Zinc coating shall be applied after machining. In the case of applying hot-dip zinc coating, and the coatings on the inside diameter surface, welding area, etc. of the flange are to be removed thereafter, the application may be on estimating the necessary working allowances.
- b) Flanges shall be coated after cleaned well by sandblasting, pickling and the like.
- c) Zinc materials used for the hot-dip coating shall be distilled zinc of JIS H 2107 or zinc ingots at least equivalent thereto in quality.

16 Test methods

16.1 Liquid penetrant testing The liquid penetrant test shall be performed, as specified in the individual steel castings standards.

16.2 Magnetic particle testing The magnetic particle test shall be performed, as specified in the individual steel castings standards.

16.3 Ultrasonic testing The ultrasonic test shall be performed, as specified in the individual steel forgings or steel castings standards.

16.4 Cupric sulfate test The cupric sulphate test on hot-dip zinc coatings shall be carried out according to the requirements of clause 5 in JIS H 0401.

17 Inspection

17.1 Inspection of shape and dimensions The shape and dimensions of flanges shall be inspected by direct measurements, limit gaugings or other means, and shall meet the requirements of clause 10.

17.2 Appearance inspection The appearance of flanges shall be inspected visually and shall meet the requirements of clause 11.

17.3 Surface finish inspection Finishing of gasket face shall be inspected by an appropriate method such as comparison between it and the reference sample that agrees with the numerical values of *Ra* given in table 7, and shall meet the requirements of table 7.

The surface finishing of the welded portion where a welding flange is jointed with a steel pipe shall be inspected visually, and meet the requirements of 12.2.

17.4 Inspection by liquid penetrant testing The liquid penetrant testing on cast steel flanges shall be carried out as specified in 16.1, and the result shall meet the requirements of 13.1.

17.5 Inspection by magnetic particle testing The magnetic particle testing on cast steel flanges shall be carried out as specified in 16.2, and the result shall meet the requirements of 13.1.

17.6 Inspection by ultrasonic testing The ultrasonic testing on forged steel or cast steel flanges shall be carried out as specified in 16.3, and the results shall meet the requirements of 13.2.

17.7 Hot-dip zinc coating inspection The hot-dip zinc coating of the flange shall be tested as specified in 16.4, and the result shall meet the requirements of 14 a).

17.8 Material inspection The material of the flange shall be tested as specified in requirements of the individual material standard unless otherwise designated by the purchaser and the result shall meet the requirements of clause 7.

17.9 Acceptance inspection The acceptance inspection of the flange shall be performed on the following inspection items. In this inspection, the sampling plan for lot inspection shall be subjected to the agreement between the parties concerned.

- a) Inspection of shape and dimensions
- b) Appearance inspection
- c) Surface finish inspection
- d) Inspection by liquid penetrant testing of cast steel flanges (as required by the purchaser)
- e) Inspection by magnetic particle testing of cast steel flanges (as required by the purchaser)
- f) Inspection by ultrasonic testing of forged steel or cast steel flanges (as required by the purchaser)
- g) Material inspection

18 Designation Flange products except integral flanges (IT) shall be designated by the number of this Standard or title of this Standard, name or classification of flange, name or classification of gasket faces ⁽⁸⁾, nominal pressure, nominal size and symbol of material.

In the case of the white flange, classification according to the presence of zinc coating (ZN) shall be appended.

The following information shall be appended.

- a) Light type (L) for light type flange for nominal pressure 10K.
- b) Welding neck flanges (WN) with substitutional dimensions of nominal pressure 5K and 10K, products with substitutional dimension (H).
- c) Distinction between type A (A), type B (B) and type C (C) for slip-on hubbed flanges (SOH) for nominal pressure 20K and 30K

Note ⁽⁸⁾ With lap joint flange (LJ), there are no gasket faces.

- Examples 1 JIS B 2220 SOP FF ZN 5K 300A SS 400 or Steel pipe flange, slip-on plate flange, full face, white flange, 5K, 300A and SS 400.
- Examples 2 JIS B 2220 LJ 5K 450A SF 390A or Steel pipe flange, lap joint flange, 5K, 450A and SF 390A.
- Examples 3 JIS B 2220 TR FF 10K 80A SCS 13A or Steel pipe flange, threaded flange, full face, 10K, 80A and SCS 13A.
- Examples 4 JIS B 2220 WN RF 10K H 1000A SFVC1 or Steel pipe flange, welding neck flange, raised face, 10K, and products with substitutional dimension, 1000A and SFVC 1
- Examples 5 JIS B 2220 SOP FF 10K L 150A S20C or Steel pipe flange, slip-on plate flange, full face, 10K, light flange, 150A and S20C
- Examples 6 JIS B 2220 BL FF 16K 200A S25C or Steel pipe flange, blank flange, full face, 16K, 200A and S25C.
- Examples 7 JIS B 2220 SOH RF 20K A 50A SUS316L or Steel pipe flange, slip-on hubbed flange, raised face, 20K, type A, 50A and SUS 316L
- Examples 8 JIS B 2220 SOH MF·M 30K C 65A SFVC2A or Steel pipe flange, slip-on hubbed flange, male seat, 30K, type C, 65A and SFVC2A
- Examples 9 JIS B 2220 TG·G 30K 100A SFVAF1 or Steel pipe flange, welding neck flange, groove seat, 30K, 100A and SFVAF1

19 Marking Flanges excluding integral flange (IT) shall be marked the following information on the periphery surface by such an indelible means as stamping, die marking, etching or spraying.

- a) Nominal pressure, nominal size and symbol of material—symbol of the nominal size, A may be omitted.

The following shall be marked after the symbol of the nominal pressure.

- 1) Symbol L for the light flange for nominal pressure 10K
- 2) Symbol H for those of the substitutional dimension for nominal pressure 5K and 10K welding neck flanges (WN)
- 3) Distinction of type A (A) type B (B) and type C(C) for slip-on hubbed flanges (SOH) for nominal pressure 20K and 30K

Examples 1 5K 300 SS 400

Examples 2 5K 450A SF 390A

Examples 3 10K 80 SCS 13A

Examples 4 10K H 1000A SFVC1

Examples 5 10K L150 S20C

Examples 6 16K 200A S25C

Examples 7 20K A 50 SUS 316L

Examples 8 30K C 65A SFVC 2A

Examples 9 30K 100 SFVA F1

- b) Melting or casting number, or, an appropriate quality control number in which melting or the casting number can be traced.
- c) Manufacturer's name, its abbreviation or trademark
- d) Other necessary information not confusable with those specified in a) to c).

Attached Table 1 Pressure-temperature rating

Unit: MPa

Nominal pressure	Material group No.		Division	Max. working pressure								
				Fluid temperature °C								
	Specified material	Reference material		T _L to 120	220	300	350	400	425	450	475	490
5K	001, 002, 003a	1.1	I	0.7	0.6	0.5	—	—	—	—	—	—
			II	0.5	0.5	0.5	—	—	—	—	—	—
			III	0.5	—	—	—	—	—	—	—	—
	021a, 021b, 022a, 022b	2.1, 2.2	I	0.7	0.6	0.5	—	—	—	—	—	—
			II	0.5	0.5	0.5	—	—	—	—	—	—
			III	0.5	—	—	—	—	—	—	—	—
	023a, 023b	2.3	I	0.7	0.6	0.5	—	—	—	—	—	—
			II	0.5	0.5	0.5	—	—	—	—	—	—
			III	0.5	—	—	—	—	—	—	—	—
10K	001, 002, 003a	1.1	I	1.4	1.2	1.0	—	—	—	—	—	—
			II	1.0	1.0	1.0	—	—	—	—	—	—
			III	1.0	—	—	—	—	—	—	—	—
	021a, 021b, 022a, 022b	2.1, 2.2	I	1.4	1.2	1.0	—	—	—	—	—	—
			II	1.0	1.0	0.9	—	—	—	—	—	—
			III	1.0	—	—	—	—	—	—	—	—
	023a, 023b	2.3	I	1.4	1.2	1.0	—	—	—	—	—	—
			II	1.0	0.9	0.8	—	—	—	—	—	—
			III	1.0	—	—	—	—	—	—	—	—
16K	002, 003a	1.1	I	2.7	2.5	2.3	2.1	1.8 ⁽⁹⁾	1.6 ⁽⁹⁾	—	—	—
			II	1.6	1.6	1.6	—	—	—	—	—	—
			III	1.6	—	—	—	—	—	—	—	—
	021a, 021b, 022a, 022b	2.1, 2.2	I	2.7	2.5	2.3	2.1	1.8	1.6	—	—	—
			II	1.6	1.6	1.6	1.6	1.5	1.5	—	—	—
			III	1.6	—	—	—	—	—	—	—	—
	023a, 023b	2.3	I	2.7	2.5	2.3	2.1	1.8	1.6	—	—	—
			II	1.6	1.6	1.5	1.4	1.3	1.3	—	—	—
			III	1.6	—	—	—	—	—	—	—	—
20K	002, 003a	1.1	I	3.4	3.1	2.9	2.6	2.3 ⁽⁹⁾	2.0 ⁽⁹⁾	—	—	—
			II	2.0	2.0	2.0	—	—	—	—	—	—
			III	2.0	—	—	—	—	—	—	—	—
	021a, 021b, 022a, 022b	2.1, 2.2	I	3.4	3.1	2.9	2.6	2.3	2.0	—	—	—
			II	2.0	2.0	2.0	2.0	1.9	1.9	—	—	—
			III	2.0	—	—	—	—	—	—	—	—
	023a, 023b	2.3	I	3.4	3.1	2.9	2.6	2.3	2.0	—	—	—
			II	2.0	2.0	1.9	1.7	1.7	1.7	—	—	—
			III	2.0	—	—	—	—	—	—	—	—
30K	002, 003a	1.1	I	5.1	4.6	4.3	3.9	3.4 ⁽⁹⁾	3.0 ⁽⁹⁾	—	—	—
			II	3.9	3.9	3.9	—	—	—	—	—	—

Notes ⁽⁹⁾ Not applicable to JIS G 5101 SC 480 of material group 002, and ASTM A 537 CL1 and ISO 9328-2 PH355 of material group 1.1

Attached Table 1 (concluded)

Unit: MPa

Nominal pressure	Material group No.		Max. working pressure									
			Division	Fluid temperature °C								
	Specified material	Reference material		T_L to 120	220	300	350	400	425	450	475	490
30K	013a	1.5	I	5.1	4.6	4.3	3.9	3.8 ⁽¹⁰⁾	3.6 ⁽¹⁰⁾	3.4 ⁽¹⁰⁾	3.0 ⁽¹⁰⁾	—
			II	3.9	3.9	3.9	3.9	3.7 ⁽¹⁰⁾	3.6 ⁽¹⁰⁾	3.4 ⁽¹⁰⁾	3.0 ⁽¹⁰⁾	—
	015a	1.9	I	5.1	4.6	4.3	3.9	3.8	3.6	3.4	3.2	3.0
			II	3.9	3.9	3.9	3.9	3.8	3.6	3.4	3.2	2.9
	021a, 021b, 022a, 022b	2.1, 2.2	I	5.1	4.6	4.3	3.9	3.8	3.6	3.4 ⁽¹¹⁾	3.2 ⁽¹¹⁾⁽¹²⁾	3.0 ⁽¹¹⁾⁽¹²⁾
			II	3.9	3.6	3.4	3.0	2.5	2.3	2.3 ⁽¹¹⁾	2.3 ⁽¹¹⁾⁽¹²⁾	2.3 ⁽¹¹⁾⁽¹²⁾
			III	3.9	—	—	—	—	—	—	—	—
	023a, 023b	2.3	I	5.1	4.6	4.3	3.9	3.8	3.6	3.4 ⁽¹³⁾	—	—
			II	3.5	3.0	2.9	2.6	2.1	2.0	2.0 ⁽¹³⁾	—	—
			III	3.5	—	—	—	—	—	—	—	—

Notes ⁽¹⁰⁾ Not applicable to ASTM A 352 LC1 of the material group 1.5

⁽¹¹⁾ Not applicable to ASTM A 351 CF3 and ISO 4991 C46 of material group 021b and 2.1

⁽¹²⁾ Not applicable to ASTM A 351 CF3M of material group 022b and 2.2, ISO 4991 C57, ISO 4991 C60, ISO 4991 C61 and ISO 4991 C61LC.

⁽¹³⁾ Not applicable to ASTM A 240 304L of material group 023a and 2.3, ASTM A 182 F304L and ISO 9328-5 X 2CrNi 1810.

Remarks 1 Pressure-temperature rating of light flange for nominal pressure 10K shall conform to clause 8.

2 For the specified materials in the column of material group No., see table 5, and for the reference materials, see reference table 1 and reference table 2.

3 Division II is the rating with some limitations put on that of Division I, while Division III is the rating with further limitations put on that of Division II. Application of these divisions shall be as given in attached table 2 depending on the type of flanges and their nominal size.

4 T_L is a minimum working temperature which is the normal temperature or below. The minimum working temperature lower than the normal temperature shall be subjected to the agreement between the parties concerned.

5 Maximum working pressure is at a temperature in the middle of the temperature shown in the table shall be obtained by the proportional interpolation method.

Attached Table 2 Application of nominal size and pressure-temperature rating of flanges

Nominal pressure		5K																							
Material group No.		001, 002, 003a												021a, 021b, 022a, 022b						023a, 023b					
Type of flanges		1.1												2.1, 2.2						2.3					
		SOP	SOH	SW	Lj	TR	WN	IT	BL	SOP	SOH	SW	TR	WN	IT	BL	SOP	SOH	SW	TR	WN	IT	BL		
Nominal size A	10	I	-	I	-	I	I	I	I	I	-	I	I	I	I	I	I	-	I	I	I	I	I		
	15	I	-	I	I	I	I	I	I	I	-	I	I	I	I	I	I	-	I	I	I	I	I		
	20	I	-	I	I	I	I	I	I	I	-	I	I	I	I	I	I	-	I	I	I	I	I		
	25	I	-	I	I	I	I	I	I	I	-	I	I	I	I	I	I	-	I	I	I	I	I		
	32	I	-	I	I	I	I	I	I	I	-	I	I	I	I	I	I	-	I	I	I	I	I		
	40	I	-	I	I	I	I	I	I	I	-	I	I	I	I	I	I	-	I	I	I	I	I		
	50	I	-	I	I	I	I	I	I	I	-	I	I	I	I	I	I	-	I	I	I	I	I		
	65	I	-	I	I	I	I	I	I	I	-	I	I	I	I	I	I	-	I	I	I	I	I		
	80	I	-	I	I	I	I	I	I	I	-	I	I	I	I	I	I	-	I	I	I	I	I		
	90	I	-	-	I	-	I	I	I	I	-	-	-	I	I	I	I	-	-	-	I	I	I		
	100	I	-	-	I	I	I	I	I	I	-	-	I	I	I	I	I	-	-	I	I	I	I		
	125	I	-	-	I	I	I	I	I	I	-	-	I	I	I	I	I	-	-	I	I	I	I		
	150	I	-	-	I	I	I	I	I	I	-	-	I	I	I	I	I	-	-	I	I	I	I		
	175	I	-	-	-	-	I	I	I	I	-	-	-	I	I	I	I	-	-	-	I	I	I		
	200	I	-	-	I	-	I	I	I	I	-	-	-	I	I	I	I	-	-	-	I	I	I		
	225	I	-	-	-	-	I	I	I	I	-	-	-	I	I	I	I	-	-	-	I	I	I		
	250	I	-	-	I	-	I	I	I	I	-	-	-	I	I	I	I	-	-	-	I	I	I		
	300	I	-	-	I	-	I	I	I	I	-	-	-	I	I	I	I	-	-	-	I	I	I		
	350	I	-	-	I	-	I	I	I	I	-	-	-	I	I	I	I	-	-	-	I	I	I		
	400	I	-	-	I	-	I	I	I	I	-	-	-	I	I	I	I	-	-	-	I	I	I		
	450	I	I	-	I	-	I	I	I	I	I	-	-	I	I	I	I	I	-	-	I	I	I		
	500	I	I	-	I	-	I	I	I	I	I	-	-	I	I	I	I	I	-	-	I	I	II		
	550	I	I	-	I	-	I	I	I	I	I	-	-	I	I	I	I	I	-	-	I	I	III		
	600	I	I	-	I	-	I	I	II	I	I	-	-	I	I	II	I	I	-	-	I	I	III		
	650	I	I	-	-	-	I	I	II	I	I	-	-	I	I	II	I	I	-	-	I	I	III		
	700	I	I	-	-	-	I	I	II	I	I	-	-	I	I	II	I	I	-	-	I	I	III		
	750	I	I	-	-	-	I	I	II	I	I	-	-	I	I	II	I	I	-	-	I	I	III		
	800	I	I	-	-	-	I	I	II	I	I	-	-	I	I	II	I	I	-	-	I	I	III		
	850	I	I	-	-	-	I	I	II	I	I	-	-	I	I	II	I	I	-	-	I	I	III		
	900	I	I	-	-	-	I	I	II	I	I	-	-	I	I	III	I	I	-	-	I	I	III		
1 000	I	I	-	-	-	I	I	II	I	I	-	-	I	I	III	I	I	-	-	I	I	III			
1 100	I	I	-	-	-	I	I	II	I	I	-	-	I	I	III	I	I	-	-	I	I	III			
1 200	I	I	-	-	-	I	I	II	I	I	-	-	I	I	III	I	I	-	-	I	I	III			
1 350	I	I	-	-	-	I	I	II	I	I	-	-	I	I	III	II	II	-	-	I	I	III			
1 500	I	I	-	-	-	I	I	II	I	I	-	-	I	I	III	II	II	-	-	I	I	III			

- Remarks 1 The upper column of the column of "Material group No." shows specified materials and the lower one, the reference materials. For information, see table 5, reference table 1 and reference table 2, respectively.
- 2 For the type of flanges, see table 1.
- 3 For the pressure-temperature rating symbols I, II and III, see attached table 1.

Attached Table 2 (continued)

Nominal pressure		10K																							
Material group No.		001, 002, 003a									021a, 021b, 022a, 022b						023a, 023b								
		1.1									2.1, 2.2						2.3								
Type of flanges		SOP	SOH	SW	LJ	TR	WN	IT	BL	SOP	SOH	SW	TR	WN	IT	BL	SOP	SOH	SW	TR	WN	IT	BL		
Nominal size A	10	I	-	I	-	I	I	I	I	I	-	I	I	I	I	I	I	-	I	I	I	I	I		
	15	I	-	I	I	I	I	I	I	I	-	I	I	I	I	I	I	-	I	I	I	I	I		
	20	I	-	I	I	I	I	I	I	I	-	I	I	I	I	I	I	-	I	I	I	I	I		
	25	I	-	I	I	I	I	I	I	I	-	I	I	I	I	I	I	-	I	I	I	I	I		
	32	I	-	I	I	I	I	I	I	I	-	I	I	I	I	I	I	-	I	I	I	I	I		
	40	I	-	I	I	I	I	I	I	I	-	I	I	I	I	I	I	-	I	I	I	I	I		
	50	I	-	I	I	I	I	I	I	I	-	I	I	I	I	I	I	-	I	I	I	I	I		
	65	I	-	I	I	I	I	I	I	I	-	I	I	I	I	I	I	-	I	I	I	I	I		
	80	I	-	I	I	I	I	I	I	I	-	I	I	I	I	I	I	-	I	I	I	I	I		
	90	I	-	-	I	-	I	I	I	I	-	-	-	I	I	I	I	-	-	-	-	I	I	I	
	100	I	-	-	I	I	I	I	I	I	-	-	-	I	I	I	I	-	-	-	-	I	I	I	
	125	I	-	-	I	I	I	I	I	I	-	-	-	I	I	I	I	-	-	-	-	I	I	I	
	150	I	-	-	I	I	I	I	I	I	-	-	-	I	I	I	I	-	-	-	-	I	I	I	
	175	I	-	-	-	-	I	I	I	I	-	-	-	-	I	I	I	-	-	-	-	I	I	I	
	200	I	-	-	I	-	I	I	I	I	-	-	-	-	I	I	I	-	-	-	-	I	I	I	
	225	I	-	-	-	-	I	I	I	I	-	-	-	-	I	I	I	-	-	-	-	I	I	I	
	250	I	I	-	I	-	I	I	I	I	I	-	-	-	I	I	I	-	-	-	-	I	I	I	
	300	I	I	-	I	-	I	I	I	I	I	-	-	-	I	I	I	-	-	-	-	I	I	I	
	350	I	I	-	I	-	I	I	I	I	I	-	-	-	I	I	I	-	-	-	-	I	I	I	
	400	I	I	-	I	-	I	I	I	I	I	-	-	-	I	I	I	-	-	-	-	I	I	II	
	450	I	I	-	I	-	I	I	I	I	I	-	-	-	I	I	I	-	-	-	-	I	I	II	
	500	I	I	-	I	-	I	I	II	I	I	-	-	-	I	I	II	-	-	-	-	I	I	III	
	550	I	I	-	I	-	I	I	II	I	I	-	-	-	I	I	II	-	-	-	-	I	I	III	
	600	I	I	-	I	-	I	I	II	I	I	-	-	-	I	I	II	-	-	-	-	I	I	III	
	650	I	I	-	-	-	I	I	II	I	I	-	-	-	I	I	II	-	-	-	-	I	I	III	
	700	I	I	-	-	-	I	I	II	I	I	-	-	-	I	I	II	-	-	-	-	I	I	III	
	750	I	I	-	-	-	I	I	II	I	I	-	-	-	I	I	II	-	-	-	-	I	I	III	
	800	I	I	-	-	-	I	I	II	II	II	-	-	-	I	I	III	-	-	-	-	I	I	III	
	850	I	I	-	-	-	I	I	II	II	II	-	-	-	I	I	III	-	-	-	-	II	II	III	
	900	I	I	-	-	-	I	I	II	II	II	-	-	-	I	I	III	-	-	-	-	II	II	III	
1 000	I	I	-	-	-	I	I	II	II	II	-	-	-	I	I	III	-	-	-	-	II	II	III		
1 100	II	I	-	-	-	I	I	II	II	II	-	-	-	I	I	III	-	-	-	-	II	II	III		
1 200	II	I	-	-	-	I	I	II	II	II	-	-	-	I	I	III	-	-	-	-	II	II	III		
1 350	II	I	-	-	-	I	I	II	II	II	-	-	-	I	I	III	-	-	-	-	II	II	III		
1 500	II	I	-	-	-	I	I	II	II	II	-	-	-	I	I	III	-	-	-	-	II	II	III		

- Remarks 1 The upper column of the column of "Material group No." shows specified materials and the lower one, the reference materials. For information, see table 5, reference table 1 and reference table 2, respectively.
- 2 For the type of flanges, see table 1.
- 3 For the pressure-temperature rating symbols I, II and III, see attached table 1.
- 4 For the nominal size of the light flanges for nominal pressure 10K, see table 6.

Attached Table 2 (continued)

Nominal pressure		16K																		
Number of material group		002, 003a						021a, 021b, 022a, 022b						023a, 023b						
		1.1						2.1, 2.2						2.3						
Type of flanges		SOH	SW	L _d	TR	WN	IT	BL	SOH	SW	TR	WN	IT	BL	SOH	SW	TR	WN	IT	BL
Nominal size A	10	I	I	-	I	I	I	I	I	I	I	I	I	I	I	I	I	I	I	I
	15	I	I	I	I	I	I	I	I	I	I	I	I	I	I	I	I	I	I	I
	20	I	I	I	I	I	I	I	I	I	I	I	I	I	I	I	I	I	I	I
	25	I	I	I	I	I	I	I	I	I	I	I	I	I	I	I	I	I	I	I
	32	I	I	I	I	I	I	I	I	I	I	I	I	I	I	I	I	I	I	I
	40	I	I	I	I	I	I	I	I	I	I	I	I	I	I	I	I	I	I	I
	50	I	I	I	I	I	I	I	I	I	I	I	I	I	I	I	I	I	I	I
	65	I	I	I	I	I	I	I	I	I	I	I	I	I	I	I	I	I	I	I
	80	I	I	I	I	I	I	I	I	I	I	I	I	I	I	I	I	I	I	I
	90	I	-	I	-	I	I	I	I	-	-	I	I	I	I	-	-	I	I	I
	100	I	-	I	I	I	I	I	I	-	I	I	I	I	I	-	I	I	I	I
	125	I	-	I	I	I	I	I	I	-	I	I	I	I	I	-	I	I	I	I
	150	I	-	I	I	I	I	I	I	-	I	I	I	I	I	-	I	I	I	I
	200	I	-	I	-	I	I	I	I	-	-	I	I	I	I	-	-	I	I	I
	250	I	-	I	-	I	I	I	I	-	-	I	I	II	II	-	-	II	II	II
	300	I	-	I	-	I	I	I	I	-	-	I	I	II	II	-	-	II	II	II
	350	I	-	I	-	I	I	I	I	-	-	I	I	II	II	-	-	II	II	II
	400	I	-	I	-	I	I	I	I	-	-	I	I	II	II	-	-	II	II	II
	450	I	-	I	-	I	I	I	II	-	-	I	I	II	II	-	-	II	II	III
	500	I	-	I	-	I	I	II	II	-	-	I	I	III	II	-	-	II	II	III
	550	I	-	I	-	I	I	II	II	-	-	I	I	III	II	-	-	II	II	III
	600	I	-	I	-	I	I	II	II	-	-	I	I	III	II	-	-	II	II	III

Remarks 1 The upper column of the column of "Material group No." shows specified materials and the lower one, the reference materials. For information, see table 5, reference table 1 and reference table 2, respectively.

2 For the type of flanges, see table 1.

3 For the pressure-temperature rating symbols I, II and III, see attached table 1.

Attached Table 2 (continued)

Nominal pressure		20K																			
Material group No		002, 003a						021a, 021b, 022a, 022b						023a, 023b							
		1.1						2.1, 2.2						2.3							
Type of flanges		SOH	SW	L _J	TR	WN	IT	BL	SOH	SW	TR	WN	IT	BL	SOH	SW	TR	WN	IT	BL	
Nominal size A	10	I	I	-	I	I	I	I	I	I	I	I	I	I	I	I	I	I	I	I	
	15	I	I	I	I	I	I	I	I	I	I	I	I	I	I	I	I	I	I	I	
	20	I	I	I	I	I	I	I	I	I	I	I	I	I	I	I	I	I	I	I	
	25	I	I	I	I	I	I	I	I	I	I	I	I	I	I	I	I	I	I	I	
	32	I	I	I	I	I	I	I	I	I	I	I	I	I	I	I	I	I	I	I	
	40	I	I	I	I	I	I	I	I	I	I	I	I	I	I	I	I	I	I	I	
	50	I	I	I	I	I	I	I	I	I	I	I	I	I	I	I	I	I	I	I	
	65	I	I	I	I	I	I	I	I	I	I	I	I	I	I	I	I	I	I	I	
	80	I	I	I	I	I	I	I	I	I	I	I	I	I	I	I	I	I	I	I	
	90	I	-	I	-	I	I	I	I	-	-	I	I	I	I	I	-	-	I	I	I
	100	I	-	I	I	I	I	I	I	-	I	I	I	I	I	I	-	I	I	I	I
	125	I	-	I	I	I	I	I	I	-	I	I	I	I	I	I	-	I	I	I	I
	150	I	-	I	I	I	I	I	I	-	I	I	I	I	II	-	-	I	I	I	II
	200	I	-	I	-	I	I	I	I	-	-	I	I	I	II	-	-	I	I	I	II
	250	I	-	I	-	I	I	I	II	-	-	I	I	II	II	-	-	I	I	I	II
	300	I	-	I	-	I	I	I	II	-	-	I	I	II	II	-	-	I	I	I	III
	350	I	-	I	-	I	I	I	II	-	-	I	I	II	II	-	-	I	I	I	III
	400	I	-	I	-	I	I	I	II	-	-	I	I	II	II	-	-	I	I	I	III
	450	I	-	I	-	I	I	II	II	-	-	I	I	II	II	-	-	I	I	I	III
	500	I	-	I	-	I	I	II	II	-	-	I	I	III	II	-	-	I	I	I	III
	550	I	-	I	-	I	I	II	II	-	-	I	I	III	II	-	-	I	I	I	III
	600	I	-	I	-	I	I	II	II	-	-	I	I	III	II	-	-	I	I	I	III

Remarks 1 The upper column of the column of "Material group No." shows specified materials and the lower one, the reference materials. For information, see table 5, reference table 1 and reference table 2, respectively.

2 For the type of flanges, see table 1.

3 For the pressure-temperature rating symbols I, II and III, see attached table 1.

Attached Table 2 (concluded)

Nominal pressure		30K																			
Material group No		002, 003a				013a				015a				021a, 021b, 022a, 022b				023a, 023b			
		1.1				1.5				1.9				2.1, 2.2				2.3			
Type of flanges		SOH	WN	IT	BL	SOH	WN	IT	BL	SOH	WN	IT	BL	SOH	WN	IT	BL	SOH	WN	IT	BL
Nominal size A	10	I	-	-	I	I	-	-	I	I	-	-	I	I	-	-	I	I	-	-	I
	15	I	I	I	I	I	I	I	I	I	I	I	I	I	I	I	I	I	I	I	I
	20	I	I	I	I	I	I	I	I	I	I	I	I	I	I	I	I	I	I	I	I
	25	I	I	I	I	I	I	I	I	I	I	I	I	I	I	I	I	I	I	I	I
	32	I	I	I	I	I	I	I	I	I	I	I	I	I	I	I	I	I	I	I	I
	40	I	I	I	I	I	I	I	I	I	I	I	I	I	I	I	I	I	I	I	II
	50	I	I	I	I	I	I	I	I	I	I	I	I	I	I	I	II	I	I	I	II
	65	I	I	I	I	I	I	I	I	I	I	I	I	I	I	I	II	I	I	I	II
	80	I	I	I	I	I	I	I	I	I	I	I	I	I	I	I	II	I	I	I	II
	90	I	I	I	I	I	I	I	I	I	I	I	I	I	I	I	II	I	I	I	II
	100	I	I	I	I	I	I	I	I	I	I	I	I	I	I	I	II	I	I	I	II
	125	I	I	I	I	I	I	I	I	I	I	I	I	I	I	I	II	I	I	I	II
	150	I	I	I	I	I	I	I	I	I	I	I	I	I	I	I	II	II	I	I	II
	200	I	I	I	I	I	I	I	I	I	I	I	I	II	I	I	II	II	I	I	II
	250	I	I	I	I	I	I	I	I	I	I	I	I	II	I	I	II	II	I	I	II
	300	I	I	I	II	I	I	I	I	I	I	I	I	II	I	I	II	II	I	I	III
	350	I	I	I	II	I	I	I	II	I	I	I	I	II	I	I	III	II	I	I	III
	400	I	I	I	II	I	I	I	II	I	I	I	II	II	I	I	III	II	I	I	III

- Remarks 1 The upper column of the column of "Material group No." shows specified materials and the lower one, the reference materials. For information, see table 5, reference table 1 and reference table 2, respectively.
- 2 For the type of flanges, see table 1.
- 3 For the pressure-temperature rating symbols I, II and III, see attached table 1.

Attached Table 3 Dimensions of gasket face

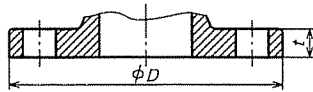

Full face (FF)

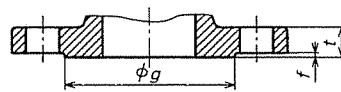

Raised face (RF)

Unit : mm

Nominal size A	Raised face (RF)									
	Nominal pressure									
	5K		10K		16K		20K		30K	
	<i>g</i>	<i>f</i>	<i>g</i>	<i>f</i>	<i>g</i>	<i>f</i>	<i>g</i>	<i>f</i>	<i>g</i>	<i>f</i>
10	39	1	46	1	46	1	46	1	52	1
15	44	1	51	1	51	1	51	1	55	1
20	49	1	56	1	56	1	56	1	60	1
25	59	1	67	1	67	1	67	1	70	1
32	70	2	76	2	76	2	76	2	80	2
40	75	2	81	2	81	2	81	2	90	2
50	85	2	96	2	96	2	96	2	105	2
65	110	2	116	2	116	2	116	2	130	2
80	121	2	126	2	132	2	132	2	140	2
90	131	2	136	2	145	2	145	2	150	2
100	141	2	151	2	160	2	160	2	160	2
125	176	2	182	2	195	2	195	2	195	2
150	206	2	212	2	230	2	230	2	235	2
175	232	2	237	2	—	—	—	—	—	—
200	252	2	262	2	275	2	275	2	280	2
225	277	2	282	2	—	—	—	—	—	—
250	317	2	324	2	345	2	345	2	345	2
300	360	3	368	3	395	3	395	3	405	3
350	403	3	413	3	440	3	440	3	450	3
400	463	3	475	3	495	3	495	3	510	3
450	523	3	530	3	560	3	560	3	—	—
500	573	3	585	3	615	3	615	3	—	—
550	630	3	640	3	670	3	670	3	—	—
600	680	3	690	3	720	3	720	3	—	—
650	735	3	740	3	—	—	—	—	—	—
700	785	3	800	3	—	—	—	—	—	—
750	840	3	855	3	—	—	—	—	—	—
800	890	3	905	3	—	—	—	—	—	—
850	940	3	955	3	—	—	—	—	—	—
900	990	3	1 005	3	—	—	—	—	—	—
1 000	1 090	3	1 110	3	—	—	—	—	—	—
1 100	1 200	3	1 220	3	—	—	—	—	—	—
1 200	1 305	3	1 325	3	—	—	—	—	—	—
1 350	1 460	3	1 480	3	—	—	—	—	—	—
1 500	1 615	3	1 635	3	—	—	—	—	—	—

Remarks 1 Dimension *D* of full face (FF) shall conform to the outside diameter *D* of the flange of the attached tables 4 to 7.

2 The thickness of the flange *t* shall conform to the attached tables 4 to 9.

Attached Table 3 (concluded)

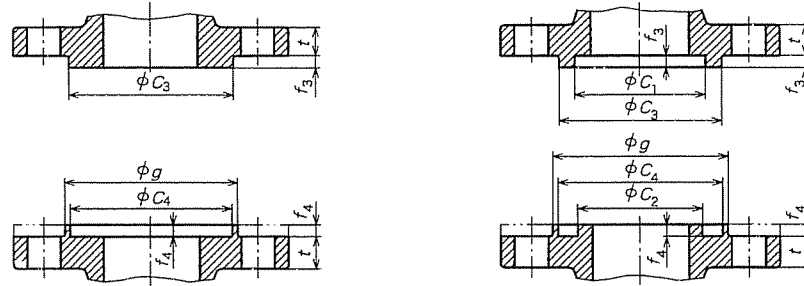

Male-female face (MF)

Tongue and groove (TG)

Unit : mm

Nominal size A	Male-female face (MF)				Tongue and groove (TG)					
	Male seat		Female seat		Tongue seat			Groove seat		
	(MF-M)		(MF-F)		(TG-T)			(TG-G)		
	C_3	f_3	C_4	f_4	C_1	C_2	f_3	C_2	C_4	f_4
10	38	6	39	5	28	38	6	27	39	5
15	42	6	43	5	32	42	6	31	43	5
20	50	6	51	5	38	50	6	37	51	5
25	60	6	61	5	45	60	6	44	61	5
32	70	6	71	5	55	70	6	54	71	5
40	75	6	76	5	60	75	6	59	76	5
50	90	6	91	5	70	90	6	69	91	5
65	110	6	111	5	90	110	6	89	111	5
80	120	6	121	5	100	120	6	99	121	5
90	130	6	131	5	110	130	6	109	131	5
100	145	6	146	5	125	145	6	124	146	5
125	175	6	176	5	150	175	6	149	176	5
150	215	6	216	5	190	215	6	189	216	5
175	—	—	—	—	—	—	—	—	—	—
200	260	6	261	5	230	260	6	229	261	5
225	—	—	—	—	—	—	—	—	—	—
250	325	6	326	5	295	325	6	294	326	5
300	375	6	376	5	340	375	6	339	376	5
350	415	6	416	5	380	415	6	379	416	5
400	475	6	476	5	440	475	6	439	476	5
450	523	6	524	5	483	523	6	482	524	5
500	575	6	576	5	535	575	6	534	576	5
550	625	6	626	5	585	625	6	584	626	5
600	675	6	676	5	635	675	6	634	676	5
650	727	6	728	5	682	727	6	681	728	5
700	777	6	778	5	732	777	6	731	778	5
750	832	6	833	5	787	832	6	786	833	5
800	882	6	883	5	837	882	6	836	883	5
850	934	6	935	5	889	934	6	888	935	5
900	987	6	988	5	937	987	6	936	988	5
1 000	1 092	6	1 094	5	1 042	1 092	6	1 040	1 094	5
1 100	1 192	6	1 194	5	1 142	1 192	6	1 140	1 194	5
1 200	1 292	6	1 294	5	1 237	1 292	6	1 235	1 294	5
1 350	1 442	6	1 444	5	1 387	1 442	6	1 385	1 444	5
1 500	1 592	6	1 594	5	1 537	1 592	6	1 535	1 594	5

- Remarks 2 The thickness of the flange t shall conform to attached tables 4 to 9.
- 3 Dimension g in male-female face (MF) and tongue and groove (TG) shall conform to dimension g of raised face (RF).
- 4 The female seats (MF-F) and the groove (TG-G) for nominal pressure 5K and 10K shall be of the shapes shown by an imaginary line of the figures.

Attached Table 4 Dimensions of flanges for nominal pressure 5K

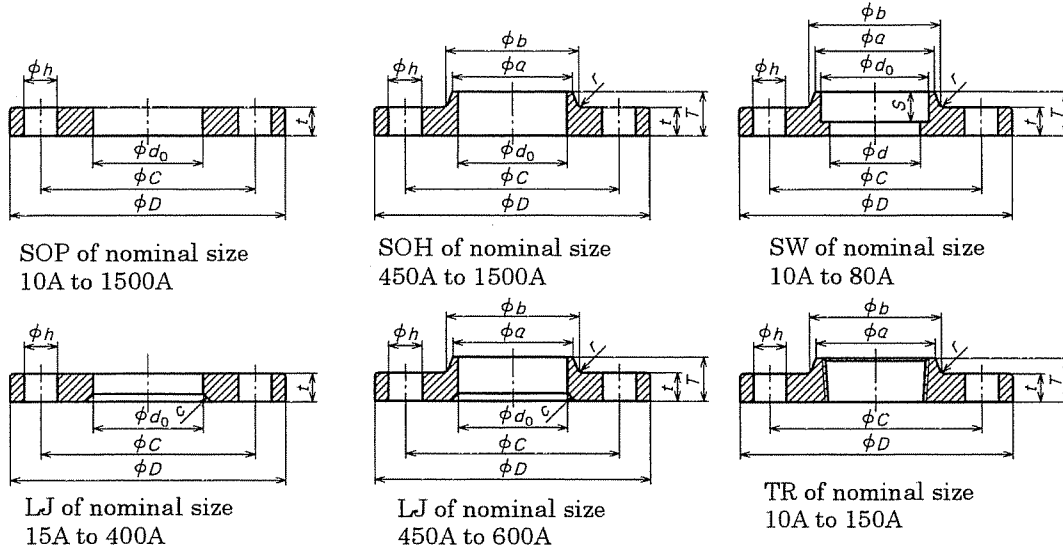

Unit : mm

Nominal size	Joined dimension					Inside diameter				Depth of socket	Nominal designation of thread	Raised face		
	Outside diameter of flange	Diameter of bolt hole centre circle	Diameter of bolt hole	Number of bolt	Nominal designation of thread of bolt	d_0	d_0	$d^{(14)}$	d			S	Diameter	Height
A	SOP, SOH, SW, LJ, TR, WN, IT, BL					SOP, SOH, SW	LJ	SW, WN	IT	SW	TR	WN, IT		
10	75	55	12	4	M10	17.8	—	12.7	10	10	Rc $\frac{3}{8}$	39	1	
15	80	60	12	4	M10	22.2	23.4	16.1	15	10	Rc $\frac{1}{2}$	44	1	
20	85	65	12	4	M10	27.7	28.9	21.6	20	13	Rc $\frac{3}{4}$	49	1	
25	95	75	12	4	M10	34.5	35.6	27.6	25	13	Rc 1	59	1	
32	115	90	15	4	M12	43.2	44.3	35.7	32	13	Rc $1 \frac{1}{4}$	70	2	
40	120	95	15	4	M12	49.1	50.4	41.6	40	13	Rc $1 \frac{1}{2}$	75	2	
50	130	105	15	4	M12	61.1	62.7	52.9	50	16	Rc 2	85	2	
65	155	130	15	4	M12	77.1	78.7	67.9	65	16	Rc $2 \frac{1}{2}$	110	2	
80	180	145	19	4	M16	90.0	91.6	80.7	80	16	Rc 3	121	2	
90	190	155	19	4	M16	102.6	104.1	93.2	90	—	—	131	2	
100	200	165	19	8	M16	115.4	116.9	105.3	100	—	Rc 4	141	2	
125	235	200	19	8	M16	141.2	143.0	130.8	125	—	Rc 5	176	2	
150	265	230	19	8	M16	166.6	168.4	155.2	150	—	Rc 6	206	2	
175	300	260	23	8	M20	192.1	—	180.1	175	—	—	232	2	
200	320	280	23	8	M20	218.0	219.5	204.7	200	—	—	252	2	
225	345	305	23	12	M20	243.7	—	229.4	225	—	—	277	2	
250	385	345	23	12	M20	269.5	271.7	254.2	250	—	—	317	2	
300	430	390	23	12	M20	321.0	322.8	304.7	300	—	—	360	3	
350	480	435	25	12	M22	358.1	360.2	339.8	340	—	—	403	3	
400	540	495	25	16	M22	409	411.2	390.6	400	—	—	463	3	
450	605	555	25	16	M22	460	462.3	441.4	450	—	—	523	3	
500	655	605	25	20	M22	511	514.4	492.2	500	—	—	573	3	
550	720	665	27	20	M24	562	565.2	543.0	550	—	—	630	3	
600	770	715	27	20	M24	613	616.0	593.8	600	—	—	680	3	
650	825	770	27	24	M24	664	—	644.6	650	—	—	735	3	
700	875	820	27	24	M24	715	—	695.4	700	—	—	785	3	
750	945	880	33	24	M30	766	—	746.2	750	—	—	840	3	
800	995	930	33	24	M30	817	—	797.0	800	—	—	890	3	
850	1 045	980	33	24	M30	868	—	847.8	850	—	—	940	3	
900	1 095	1 030	33	24	M30	919	—	898.6	900	—	—	990	3	
1 000	1 195	1 130	33	28	M30	1 021	—	1 000.2	1 000	—	—	1 090	3	
1 100	1 305	1 240	33	28	M30	1 122	—	1 098.6	1 100	—	—	1 200	3	
1 200	1 420	1 350	33	32	M30	1 224	—	1 200.2	1 200	—	—	1 305	3	
1 350	1 575	1 505	33	32	M30	1 376	—	1 346.2	1 350	—	—	1 460	3	
1 500	1 730	1 660	33	36	M30	1 529	—	1 498.6	1 500	—	—	1 615	3	

Note ⁽¹⁴⁾ Adjustment shall be made according to the inside diameter of the steel pipes to be joined with.

Attached Table 4 (concluded)

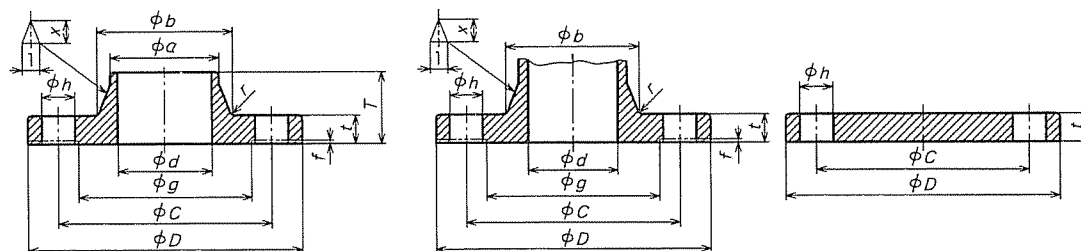

WN of nominal size 10A to 1500A IT of nominal size 10A to 1500A BL of nominal size 10A to 1500A

Unit : mm

Nominal size	Thickness of flange		Diameter of hub Small diameter side		Diameter of hub Large diameter side		Taper of hub		Total length of flange		Chamfering ⁽¹⁶⁾	Radius of fillet		Substitutional dimension of WN ⁽¹⁷⁾	
	<i>t</i>	<i>t</i>	<i>a</i>	<i>a</i>	<i>b</i>	<i>b</i> ⁽¹⁵⁾	<i>x</i>	Minimum <i>x</i>	<i>T</i>	<i>T</i>	<i>c</i>	<i>r</i>	<i>r</i> ⁽¹⁵⁾	Thickness of flange	Taper of hub
	Except for BL	BL	SOH, SW, LJ, TR	WN	SOH, SW, LJ, TR	WN, IT	WN	IT	SOH, SW, LJ, TR	WN	LJ	SOH, SW, LJ, TR	WN, IT	WN	
A															
10	9	9	23	17.3	26	26	1.25	1.25	13	24	—	4	4	—	—
15	9	9	27	21.7	30	31	1.25	1.25	13	25	3	4	4	—	—
20	10	10	33	27.2	36	38	1.25	1.25	15	28	3	4	4	—	—
25	10	10	41	34.0	44	46	1.25	1.25	17	30	3	4	4	—	—
32	12	12	50	42.7	53	55	1.25	1.25	19	33	4	4	4	—	—
40	12	12	56	48.6	60	62	1.25	1.25	20	34	4	4	4	—	—
50	14	14	69	60.5	73	73	1.25	1.25	24	36	4	4	4	—	—
65	14	14	86	76.3	91	91	1.25	1.25	27	39	5	4	4	—	—
80	14	14	99	89.1	105	105	1.25	1.25	30	41	5	4	4	—	—
90	14	14	—	101.6	—	117	1.25	1.25	—	41	5	—	4	—	—
100	16	16	127	114.3	130	128	1.25	1.25	36	41	5	4	4	—	—
125	16	16	154	139.8	161	156	1.25	1.25	40	43	6	4	4	—	—
150	18	18	182	165.2	189	184	1.25	1.25	40	49	6	4	4	—	—
175	18	18	—	190.7	—	209	1.25	1.25	—	49	—	—	4	—	—
200	20	20	—	216.3	—	235	1.25	1.25	—	53	6	—	4	—	—
225	20	20	—	241.8	—	261	1.25	1.25	—	54	—	—	4	—	—
250	22	22	—	267.4	—	290	1.25	1.25	—	61	6	—	4	—	—
300	22	22	—	318.5	—	342	1.25	1.25	—	62	9	—	4	—	—
350	24	24	—	355.6	—	385	1.25	1.25	—	73	9	—	4	—	—
400	24	24	—	406.4	—	438	1.25	1.25	—	76	9	—	4	—	—
450	24	24	495	457.2	500	491	1.25	1.25	40	79	9	5	5	—	—
500	24	24	546	508.0	552	541	1.25	1.25	40	79	9	5	5	—	—
550	26	26	597	558.8	603	593	1.25	1.25	42	81	9	5	5	—	—
600	26	26	648	609.6	654	643	1.25	1.25	44	81	9	5	5	—	—
650	26	28	702	660.4	708	698	1.25	1.25	48	85	—	5	5	—	—
700	26	30	751	711.2	758	748	1.5	1.5	48	94	—	5	5	36	1.25
750	28	32	802	762.0	810	802	1.5	1.5	52	100	—	5	5	38	1.25
800	28	34	854	812.8	862	852	1.5	1.5	52	100	—	5	5	38	1.25
850	28	36	904	863.6	912	902	1.75	1.75	54	108	—	5	5	38	1.5
900	30	36	956	914.4	964	952	1.75	1.75	56	108	—	5	5	40	1.5
1 000	32	40	1 058	1 016.0	1 066	1 052	2	2	60	116	—	5	5	50	1.5
1 100	32	44	1 158	1 117.6	1 170	1 162	2	2	71	136	—	7	8	56	1.5
1 200	34	48	1 260	1 219.2	1 272	1 272	2	2	77	155	—	7	8	62	1.5
1 350	34	54	1 414	1 371.6	1 426	1 427	2	2	80	164	—	7	8	62	1.5
1 500	36	58	1 568	1 524.0	1 580	1 582	2	2	86	172	—	7	10	66	1.5

Notes (15) With IT flanges, this dimension is shown for reference.

(16) This may be rounded off with the dimension *c* as a radius.

(17) This dimension may be determined on the agreement between the parties concerned.

Attached Table 5 Dimensions of flanges for nominal pressure 10K

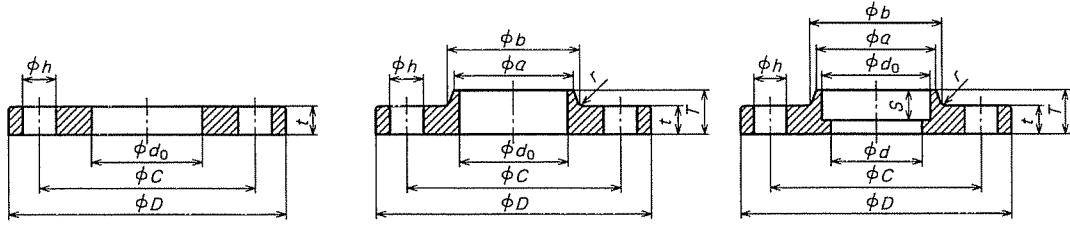

WN of nominal size 10A to 1500A

SOH of nominal size 250A to 1500A

SW of nominal size 10A to 80A

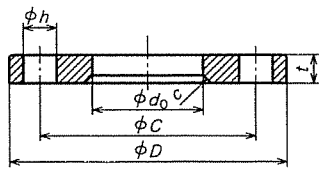

LJ of nominal size 15A to 200A

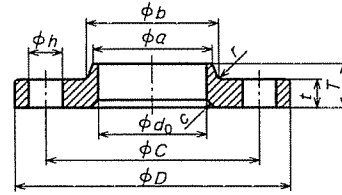

LJ of nominal size 250A to 600A

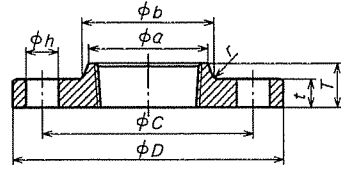

TR of nominal size 10A to 150A

Unit : mm

Nominal size	Joined dimension					Inside diameter				Depth of socket	Nominal designation of thread	Raised face			
	Outside diameter of flange	Diameter of bolt hole centre circle	Diameter of bolt hole	Number of bolt	Nominal designation of thread of bolt	Outside diameter of flange			(informative)			S	TR	Diameter	Height
						d ₀	d ₀	d ⁽¹⁸⁾							
A	SOP, SOH, SW, LJ, TR, WN, IT, BL					SOP, SOH, SW	LJ	SW, WN	IT	SW	TR	WN, IT			
10	90	65	15	4	M12	17.8	—	12.7	10	10	Rc 3/8	46	1		
15	95	70	15	4	M12	22.2	23.4	16.1	15	10	Rc 1/2	51	1		
20	100	75	15	4	M12	27.7	28.9	21.6	20	13	Rc 3/4	56	1		
25	125	90	19	4	M16	34.5	35.6	27.6	25	13	Rc 1	67	1		
32	135	100	19	4	M16	43.2	44.3	35.7	32	13	Rc 1 1/4	76	2		
40	140	105	19	4	M16	49.1	50.4	41.6	40	13	Rc 1 1/2	81	2		
50	155	120	19	4	M16	61.1	62.7	52.9	50	16	Rc 2	96	2		
65	175	140	19	4	M16	77.1	78.7	67.9	65	16	Rc 2 1/2	116	2		
80	185	150	19	8	M16	90.0	91.6	80.7	80	16	Rc 3	126	2		
90	195	160	19	8	M16	102.6	104.1	93.2	90	—	—	136	2		
100	210	175	19	8	M16	115.4	116.9	105.3	100	—	Rc 4	151	2		
125	250	210	23	8	M20	141.2	143.0	130.8	125	—	Rc 5	182	2		
150	280	240	23	8	M20	166.6	168.4	155.2	150	—	Rc 6	212	2		
175	305	265	23	12	M20	192.1	—	180.1	175	—	—	237	2		
200	330	290	23	12	M20	218.0	219.5	204.7	200	—	—	262	2		
225	350	310	23	12	M20	243.7	—	229.4	225	—	—	282	2		
250	400	355	25	12	M22	269.5	271.7	254.2	250	—	—	324	2		
300	445	400	25	16	M22	321.0	322.8	304.7	300	—	—	368	3		
350	490	445	25	16	M22	358.1	360.2	339.8	340	—	—	413	3		
400	560	510	27	16	M24	409	411.2	390.6	400	—	—	475	3		
450	620	565	27	20	M24	460	462.3	441.4	450	—	—	530	3		
500	675	620	27	20	M24	511	514.4	492.2	500	—	—	585	3		
550	745	680	33	20	M30	562	565.2	543.0	550	—	—	640	3		
600	795	730	33	24	M30	613	616.0	593.8	600	—	—	690	3		
650	845	780	33	24	M30	664	—	644.6	650	—	—	740	3		
700	905	840	33	24	M30	715	—	695.4	700	—	—	800	3		
750	970	900	33	24	M30	766	—	746.2	750	—	—	855	3		
800	1 020	950	33	28	M30	817	—	797.0	800	—	—	905	3		
850	1 070	1 000	33	28	M30	868	—	847.8	850	—	—	955	3		
900	1 120	1 050	33	28	M30	919	—	898.6	900	—	—	1 005	3		
1 000	1 235	1 160	39	28	M36	1 021	—	1 000.2	1 000	—	—	1 110	3		
1 100	1 345	1 270	39	28	M36	1 122	—	1 098.6	1 100	—	—	1 220	3		
1 200	1 465	1 380	39	32	M36	1 224	—	1 200.2	1 200	—	—	1 325	3		
1 350	1 630	1 540	45	36	M42	1 376	—	1 346.2	1 350	—	—	1 480	3		
1 500	1 795	1 700	45	40	M42	1 529	—	1 498.6	1 500	—	—	1 635	3		

Note (18) Adjustment shall be made according to the inside diameter of the steel pipes to be joined with.

Attached Table 5 (concluded)

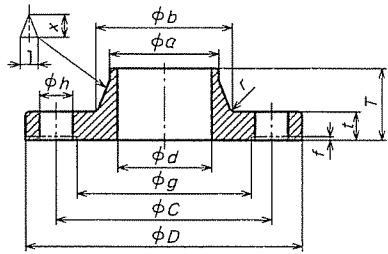

WN of nominal size 10A to 1500A

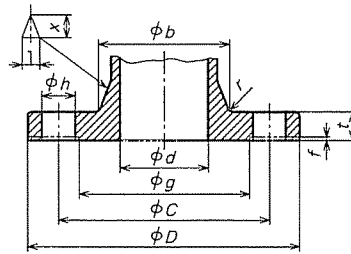

IT of nominal size 10A to 1500A

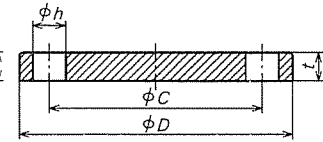

BL of nominal size 10A to 1500A

Unit : mm

Nominal size	Thickness of flange		Diameter of hub Small diameter side		Diameter of hub Large diameter side		Taper of hub		Total length of flange		Chamfering ⁽²⁰⁾	Radius of fillet		Substitutional dimension of WN ⁽²¹⁾	
	<i>t</i>	<i>t</i>	<i>a</i>	<i>a</i>	<i>b</i>	<i>b</i> ⁽¹⁹⁾	Min.		<i>T</i>	<i>T</i>		<i>c</i>	<i>r</i>	<i>r</i> ⁽¹⁹⁾	Thickness of flange
	Except for BL	BL	SOH, SW, LJ, TR	WN	SOH, SW, LJ, TR	WN, IT	WN	IT	SOH, SW, LJ, TR	WN	LJ	SOH, SW, LJ, TR	WN, IT	WN	
10	12	12	23	17.3	26	28	1.25	1.25	16	29	—	4	4	—	—
15	12	12	27	21.7	30	33	1.25	1.25	16	31	3	4	4	—	—
20	14	14	33	27.2	36	38	1.25	1.25	20	32	3	4	4	—	—
25	14	14	41	34.0	44	47	1.25	1.25	20	36	3	4	4	—	—
32	16	16	50	42.7	53	56	1.25	1.25	22	38	4	4	4	—	—
40	16	16	56	48.6	60	62	1.25	1.25	24	38	4	4	4	—	—
50	16	16	69	60.5	73	75	1.25	1.25	24	40	4	4	4	—	—
65	18	18	86	76.3	91	92	1.25	1.25	27	44	5	4	4	—	—
80	18	18	99	89.1	105	105	1.25	1.25	30	45	5	4	5	—	—
90	18	18	—	101.6	—	117	1.25	1.25	—	45	5	—	5	—	—
100	18	18	127	114.3	130	130	1.25	1.25	36	45	5	4	5	—	—
125	20	20	154	139.8	161	156	1.25	1.25	40	47	6	4	5	—	—
150	22	22	182	165.2	189	184	1.25	1.25	40	53	6	4	5	—	—
175	22	22	—	190.7	—	210	1.25	1.25	—	55	—	—	5	—	—
200	22	22	—	216.3	—	238	1.25	1.25	—	58	6	—	5	—	—
225	22	22	—	241.8	—	261	1.25	1.25	—	58	—	—	5	—	—
250	24	24	288	267.4	292	292	1.25	1.25	36	65	6	6	6	—	—
300	24	24	340	318.5	346	345	1.25	1.25	38	68	9	6	6	—	—
350	26	26	380	355.6	386	388	1.25	1.25	42	79	9	6	6	—	—
400	28	28	436	406.4	442	442	1.25	1.25	44	85	9	6	6	—	—
450	30	30	496	457.2	502	495	1.25	1.25	48	90	9	6	6	—	—
500	30	30	548	508.0	554	546	1.5	1.5	48	99	9	6	6	40	1.25
550	32	34	604	558.8	610	597	1.75	1.75	52	111	9	6	6	42	1.5
600	32	36	656	609.6	662	648	1.75	1.75	52	112	9	6	6	42	1.5
650	34	38	706	660.4	712	700	1.75	1.75	56	116	—	6	6	44	1.5
700	34	40	762	711.2	770	754	2	2	58	132	—	6	6	56	1.5
750	36	44	816	762.0	824	807	2	2	62	139	—	6	6	60	1.5
800	36	46	868	812.8	876	858	2	2	64	139	—	6	6	60	1.5
850	36	48	920	863.6	928	908	2	2	66	139	—	6	6	60	1.5
900	38	50	971	914.4	979	959	2	2	70	140	—	6	6	62	1.5
1 000	40	56	1 073	1 016.0	1 081	1 065	2	2	74	151	—	6	6	66	1.5
1 100	42	62	1 175	1 117.6	1 185	1 174	2	2	95	170	—	8	10	72	1.5
1 200	44	66	1 278	1 219.2	1 290	1 281	2	2	101	182	—	8	10	76	1.5
1 350	48	74	1 432	1 371.6	1 450	1 438	2	2	110	200	—	8	10	82	1.5
1 500	50	82	1 585	1 524.0	1 605	1 598	2	2	123	218	—	8	12	88	1.5

Notes ⁽¹⁹⁾ With IT flanges, this dimension is shown for reference.

⁽²⁰⁾ This may be rounded off with the dimension *c* as a radius.

⁽²¹⁾ This dimension may be determined on the agreement between the parties concerned.

Attached Table 6 Dimensions of light flanges for nominal pressure 10K

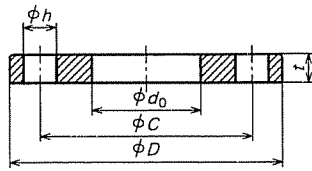

SOP of nominal size 10A to 350A

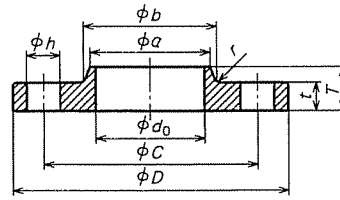

SOH of nominal size 400A

Unit : mm

Nominal size	Joined dimension					Inside diameter	Thickness of flange	Diameter of hub		Total length of flange	Radius of fillet
	Outside diameter of flange	Diameter of bolt hole centre circle	Diameter of bolt hole	Number of bolt	Nominal designation of thread of bolt			a	b		
A	D	C	h			d ₀	t			T	r
	SOP, SOH					SOP, SOH	SOP, SOH	SOH		SOH	SOH
10	90	65	12	4	M10	17.8	9	—	—	—	—
15	95	70	12	4	M10	22.2	9	—	—	—	—
20	100	75	12	4	M10	27.7	10	—	—	—	—
25	125	90	15	4	M12	34.5	12	—	—	—	—
32	135	100	15	4	M12	43.2	12	—	—	—	—
40	140	105	15	4	M12	49.1	12	—	—	—	—
50	155	120	15	4	M12	61.1	14	—	—	—	—
65	175	140	15	4	M12	77.1	14	—	—	—	—
80	185	150	15	8	M12	90.0	14	—	—	—	—
90	195	160	15	8	M12	102.6	14	—	—	—	—
100	210	175	15	8	M12	115.4	16	—	—	—	—
125	250	210	19	8	M16	141.2	18	—	—	—	—
150	280	240	19	8	M16	166.6	18	—	—	—	—
175	305	265	19	12	M16	192.1	20	—	—	—	—
200	330	290	19	12	M16	218.0	20	—	—	—	—
225	350	310	19	12	M16	243.7	20	—	—	—	—
250	400	355	23	12	M20	269.5	22	—	—	—	—
300	445	400	23	16	M20	321.0	22	—	—	—	—
350	490	445	23	16	M20	358.1	24	—	—	—	—
400	560	510	25	16	M22	409	24	436	442	36	5

Attached Table 7 Dimensions of flanges for nominal pressure 16K

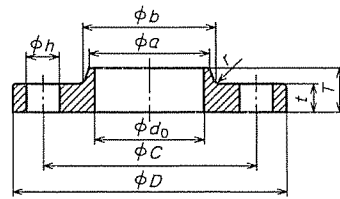

SOH of nominal size 10A to 600A

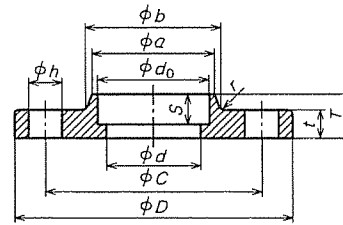

SW of nominal size 10A to 80A

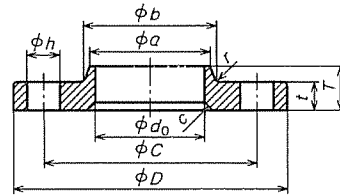

LJ of nominal size 15A to 600A

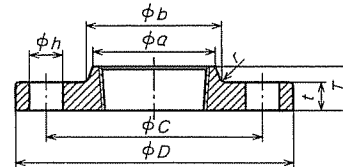

TR of nominal size 10A to 150A

Unit : mm

Nominal size	Joined dimension					Inside diameter				Depth of socket	Nominal designation of thread	Raised face			
	Outside diameter of flange	Diameter of bolt hole centre circle	Diameter of bolt hole	Number of bolts	Nominal designation of thread of bolt	d_0	d_0	$d^{(22)}$	d			S		Diameter	Height
														D	C
A	SOH, SW, LJ, TR, WN, IT, BL					SOH, SW	LJ	SW, WN	IT	SW	TR	WN, IT			
10	90	65	15	4	M12	17.8	—	12.7	10	10	Rc $\frac{3}{8}$	46	1		
15	95	70	15	4	M12	22.2	23.4	16.1	15	10	Rc $\frac{1}{2}$	51	1		
20	100	75	15	4	M12	27.7	28.9	21.4	20	13	Rc $\frac{3}{4}$	56	1		
25	125	90	19	4	M16	34.5	35.6	27.2	25	13	Rc 1	67	1		
32	135	100	19	4	M16	43.2	44.3	35.5	32	13	Rc $1\frac{1}{4}$	76	2		
40	140	105	19	4	M16	49.1	50.4	41.2	40	13	Rc $1\frac{1}{2}$	81	2		
50	155	120	19	8	M16	61.1	62.7	52.7	50	16	Rc 2	96	2		
65	175	140	19	8	M16	77.1	78.7	65.9	65	16	Rc $2\frac{1}{2}$	116	2		
80	200	160	23	8	M20	90.0	91.6	78.1	80	16	Rc 3	132	2		
90	210	170	23	8	M20	102.6	104.1	90.2	90	—	—	145	2		
100	225	185	23	8	M20	115.4	116.9	102.3	100	—	Rc 4	160	2		
125	270	225	25	8	M22	141.2	143.0	126.6	125	—	Rc 5	195	2		
150	305	260	25	12	M22	166.6	168.4	151.0	150	—	Rc 6	230	2		
200	350	305	25	12	M22	218.0	219.5	199.9	200	—	—	275	2		
250	430	380	27	12	M24	269.5	271.7	248.8	250	—	—	345	2		
300	480	430	27	16	M24	321.0	322.8	297.9	300	—	—	395	3		
350	540	480	33	16	M30 × 3	358.1	360.2	333.4	335	—	—	440	3		
400	605	540	33	16	M30 × 3	409	411.2	381.0	380	—	—	495	3		
450	675	605	33	20	M30 × 3	460	462.3	431.8	430	—	—	560	3		
500	730	660	33	20	M30 × 3	511	514.4	482.6	480	—	—	615	3		
550	795	720	39	20	M36 × 3	562	565.2	533.4	530	—	—	670	3		
600	845	770	39	24	M36 × 3	613	616.0	584.2	580	—	—	720	3		

Note ⁽²²⁾ Adjustment shall be made according to the inside diameter of the steel pipes to be joined with.

Attached Table 7 (concluded)

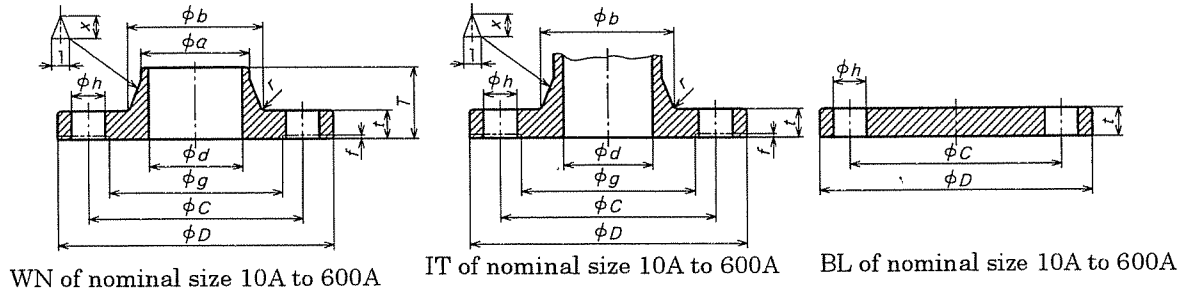

Unit : mm

Nominal size	Thickness of flange t	Diameter of hub Small diameter side		Diameter of hub Large diameter side		Taper of hub		The total length of flange			Chamfering ⁽²⁴⁾ c	Radius of fillet $r^{(23)}$
		a	a	b	$b^{(23)}$	x	Min. x	T	T	T		
A	SOH, SW, LJ, TR, WN, IT, BL	SOH, SW, LJ, TR	WN	SOH, SW, LJ, TR	WN, IT	WN	IT	SOH, SW, LJ	TR	WN	LJ	SOH, SW, LJ, TR, WN, IT
10	12	26	17.3	28	29	1.25	1.25	16	16	31	—	4
15	12	30	21.7	32	34	1.25	1.25	16	16	32	3	4
20	14	38	27.2	42	39	1.25	1.25	20	20	34	3	4
25	14	46	34.0	50	47	1.25	1.25	20	20	36	3	4
32	16	56	42.7	60	56	1.25	1.25	22	22	39	4	5
40	16	62	48.6	66	62	1.25	1.25	24	24	39	4	5
50	16	76	60.5	80	75	1.25	1.25	24	24	40	4	5
65	18	94	76.3	98	92	1.25	1.25	26	27	46	5	5
80	20	108	89.1	112	105	1.25	1.25	28	30	49	5	6
90	20	120	101.6	124	118	1.25	1.25	30	—	50	5	6
100	22	134	114.3	138	134	1.25	1.25	34	36	56	5	6
125	22	164	139.8	170	162	1.25	1.25	34	40	60	6	6
150	24	196	165.2	202	192	1.25	1.25	38	40	69	6	6
200	26	244	216.3	252	244	1.25	1.25	40	—	73	6	6
250	28	304	267.4	312	298	1.25	1.25	44	—	81	6	6
300	30	354	318.5	364	352	1.25	1.25	48	—	88	9	8
350	34	398	355.6	408	398	1.25	1.25	52	—	104	9	8
400	38	446	406.4	456	452	1.25	1.25	60	—	115	9	10
450	40	504	457.2	514	510	1.25	1.25	64	—	126	9	10
500	42	558	508.0	568	561	1.25	1.25	68	—	128	9	10
550	44	612	558.8	622	616	1.25	1.25	70	—	135	9	10
600	46	666	609.6	676	670	1.25	1.25	74	—	141	9	10

Notes ⁽²³⁾ With IT flanges, this dimension is shown for reference.⁽²⁴⁾ This may be rounded off with the dimension c as a radius.

Attached Table 8 Dimensions of flanges for nominal pressure 20K

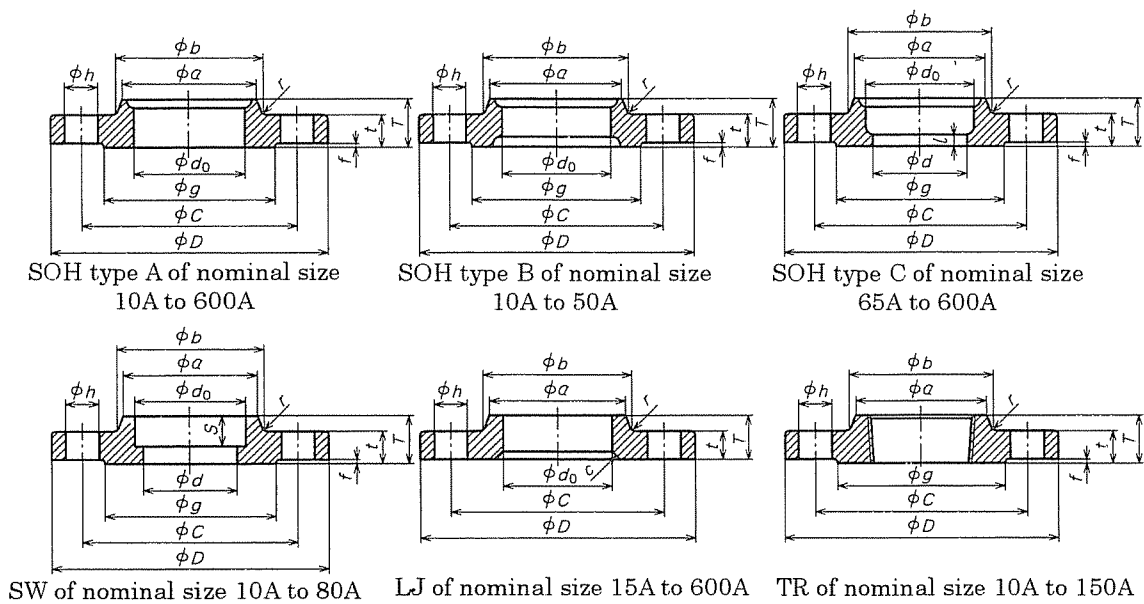

Unit : mm

Nominal size	Joined dimension					Inside diameter				Depth of socket	Nominal designation of thread	Raised face		
	Outside diameter of flange	Diameter of bolt of bolt centre circle	Diameter of bolt hole	Number of bolts	Nominal designation of thread of bolt	d_0	d_0	$d^{(25)}$	d			S	g	f
A	D	C	h			d_0	d_0	$d^{(25)}$	d	S				
10	90	65	15	4	M12	17.8	—	12.7	10	10	Rc $3/8$	46	1	
15	95	70	15	4	M12	22.2	23.4	16.1	15	10	Rc $1/2$	51	1	
20	100	75	15	4	M12	27.7	28.9	21.4	20	13	Rc $3/4$	56	1	
25	125	90	19	4	M16	34.5	35.6	27.2	25	13	Rc 1	67	1	
32	135	100	19	4	M16	43.2	44.3	35.5	32	13	Rc $1 1/4$	76	2	
40	140	105	19	4	M16	49.1	50.4	41.2	40	13	Rc $1 1/2$	81	2	
50	155	120	19	8	M16	61.1	62.7	52.7	50	16	Rc 2	96	2	
65	175	140	19	8	M16	77.1	78.7	65.9	65	16	Rc $2 1/2$	116	2	
80	200	160	23	8	M20	90.0	91.6	78.1	80	16	Rc 3	132	2	
90	210	170	23	8	M20	102.6	104.1	90.2	90	—	—	145	2	
100	225	185	23	8	M20	115.4	116.9	102.3	100	—	Rc 4	160	2	
125	270	225	25	8	M22	141.2	143.0	126.6	125	—	Rc 5	195	2	
150	305	260	25	12	M22	166.6	168.4	151.0	150	—	Rc 6	230	2	
200	350	305	25	12	M22	218.0	219.5	199.9	200	—	—	275	2	
250	430	380	27	12	M24	269.5	271.7	248.8	250	—	—	345	2	
300	480	430	27	16	M24	321.0	322.8	297.9	300	—	—	395	3	
350	540	480	33	16	M30×3	358.1	360.2	333.4	335	—	—	440	3	
400	605	540	33	16	M30×3	409	411.2	381.0	380	—	—	495	3	
450	675	605	33	20	M30×3	460	462.3	431.8	430	—	—	560	3	
500	730	660	33	20	M30×3	511	514.4	482.6	480	—	—	615	3	
550	795	720	39	20	M36×3	562	565.2	533.4	530	—	—	670	3	
600	845	770	39	24	M36×3	613	616.0	584.2	580	—	—	720	3	

Note ⁽²⁵⁾ Adjustment shall be made according to the inside diameter of the steel pipes to be jointed with.

Attached Table 8 (concluded)

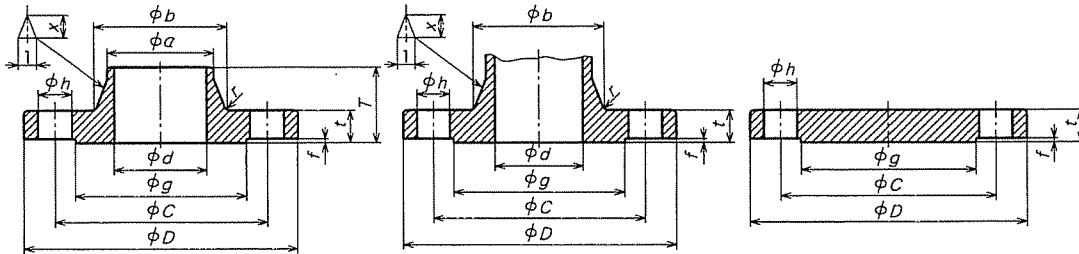

WN of nominal size 10A to 600A IT of nominal size 10A to 600A BL of nominal size 10A to 600A

Unit : mm

Nominal size	Thickness of flange		Diameter of hub Small diameter side		Diameter of hub Large diameter side		Taper of hub		The total length of flange		Chamfering (27)	Radius of fillet	Stopper
	<i>t</i>	<i>t</i>	<i>a</i>	<i>a</i>	<i>b</i>	<i>b</i> ⁽²⁶⁾	<i>x</i>	Min. <i>x</i>	<i>T</i>	<i>T</i>	<i>c</i>	<i>r</i> ⁽²⁶⁾	<i>l</i>
	Except for BL	BL	SOH, SW, LJ, TR	WN	SOH, SW, LJ, TR	WN, IT	WN	IT	SOH, SW, LJ, TR	WN	LJ	SOH, SW, LJ, TR, WN, IT	SOH Type C
A													
10	14	14	30	17.3	32	29	1.25	1.25	20	33	—	4	—
15	14	14	34	21.7	36	34	1.25	1.25	20	34	3	4	—
20	16	16	40	27.2	42	39	1.25	1.25	22	36	3	4	—
25	16	16	48	34.0	50	47	1.25	1.25	24	38	3	4	—
32	18	18	56	42.7	60	56	1.25	1.25	26	41	4	5	—
40	18	18	62	48.6	66	62	1.25	1.25	26	41	4	5	—
50	18	18	76	60.5	80	75	1.25	1.25	26	42	4	5	—
65	20	20	100	76.3	104	92	1.25	1.25	30	48	5	5	6
80	22	22	113	89.1	117	105	1.25	1.25	34	51	5	6	6
90	24	24	126	101.6	130	118	1.25	1.25	36	54	5	6	6
100	24	24	138	114.3	142	134	1.25	1.25	36	58	5	6	6
125	26	26	166	139.8	172	162	1.25	1.25	40	64	6	6	6
150	28	28	196	165.2	202	192	1.25	1.25	42	73	6	6	6
200	30	30	244	216.3	252	244	1.25	1.25	46	77	6	6	6
250	34	34	304	267.4	312	298	1.25	1.25	52	87	6	6	6
300	36	36	354	318.5	364	352	1.25	1.25	56	94	9	8	6
350	40	40	398	355.6	408	398	1.25	1.25	62	110	9	8	6
400	46	46	446	406.4	456	452	1.25	1.25	70	123	9	10	7
450	48	48	504	457.2	514	510	1.25	1.25	78	134	9	10	7
500	50	50	558	508.0	568	561	1.25	1.25	84	136	9	10	7
550	52	52	612	558.8	622	616	1.25	1.25	90	143	9	10	7
600	54	56	666	609.6	676	670	1.25	1.25	96	149	9	10	7

Notes ⁽²⁶⁾ With IT flanges, this dimension is shown for reference.

⁽²⁷⁾ This may be rounded off with the dimension *c* as a radius.

Attached Table 9 Dimensions of flanges for nominal pressure 30K

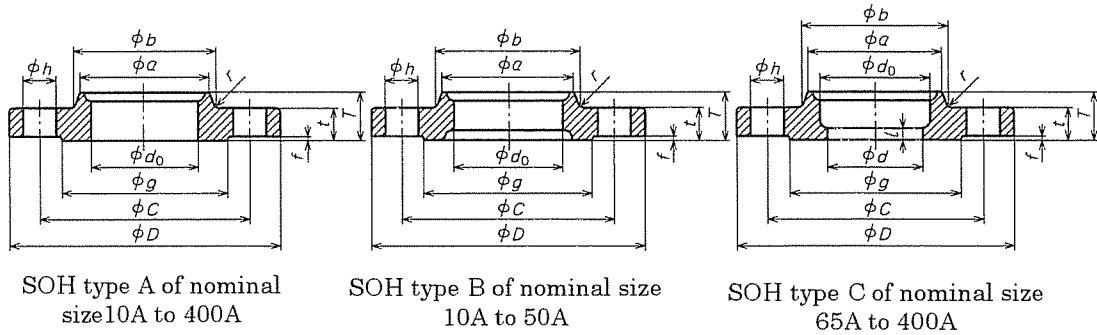

Unit : mm

Nominal size	Joined dimension					Inside diameter			Raised face	
	Outside diameter of flange <i>D</i>	Diameter of bolt hole centre circle <i>C</i>	Diameter of bolt hole <i>h</i>	Number of bolts	Nominal designation of thread of bolt	<i>d₀</i>	<i>d</i> ⁽²⁸⁾	<i>d</i> (informative)	Diameter	Height
									<i>g</i>	<i>f</i>
	SOH, WN, IT, BL					SOH	SOH, WN	IT	SOH, WN, IT, BL	
A										
10	110	75	19	4	M16	17.8	—	—	52	1
15	115	80	19	4	M16	22.2	16.1	15	55	1
20	120	85	19	4	M16	27.7	21.4	20	60	1
25	130	95	19	4	M16	34.5	27.2	25	70	1
32	140	105	19	4	M16	43.2	35.5	32	80	2
40	160	120	23	4	M20	49.1	41.2	40	90	2
50	165	130	19	8	M16	61.1	52.7	50	105	2
65	200	160	23	8	M20	77.1	65.9	65	130	2
80	210	170	23	8	M20	90.0	78.1	80	140	2
90	230	185	25	8	M22	102.6	90.2	90	150	2
100	240	195	25	8	M22	115.4	102.3	100	160	2
125	275	230	25	8	M22	141.2	126.6	125	195	2
150	325	275	27	12	M24	166.6	151.0	150	235	2
200	370	320	27	12	M24	218.0	199.9	200	280	2
250	450	390	33	12	M30×3	269.5	248.8	250	345	2
300	515	450	33	16	M30×3	321.0	297.9	300	405	3
350	560	495	33	16	M30×3	358.1	333.4	335	450	3
400	630	560	39	16	M36×3	409	381.0	380	510	3

Note (28) Adjustment shall be made according to the inside diameter of the steel pipes to be joined with.

Attached Table 9 (concluded)

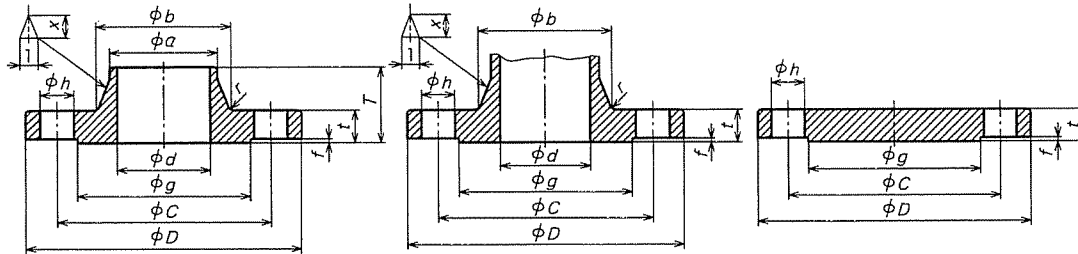

WN of nominal size 15A to 400A IT of nominal size 15A to 400A BL of nominal size 10A to 400A

Unit : mm

Nominal size	Thickness of flange t	Diameter of hub Small diameter side		Diameter of hub Large diameter side		Taper of hub Min.		The total length of flange		Radius of fillet		Stopper l
		a	a	b	$b^{(29)}$	x	x	T	T	r	$r^{(29)}$	
		SOH, WN, IT, BL	SOH, WN	SOH, WN, IT	SOH, WN, IT	WN, IT	WN, IT	SOH, WN	SOH, WN	SOH, WN, IT	WN, IT	
A												
10	16	30	—	34	—	—	—	24	—	4	—	—
15	18	36	21.7	40	40	1.25	1.25	26	45	5	6	—
20	18	42	27.2	46	44	1.25	1.25	28	45	5	6	—
25	20	50	34.0	54	52	1.25	1.25	30	48	5	6	—
32	22	60	42.7	64	62	1.25	1.25	32	52	6	6	—
40	22	66	48.6	70	70	1.25	1.25	34	54	6	6	—
50	22	82	60.5	86	84	1.25	1.25	36	57	6	8	—
65	26	102	76.3	106	104	1.25	1.25	40	69	8	8	6
80	28	115	89.1	121	118	1.25	1.25	44	73	8	8	6
90	30	128	101.6	134	130	1.25	1.25	46	74	8	8	6
100	32	141	114.3	147	142	1.25	1.25	48	76	8	8	6
125	36	166	139.8	172	172	1.25	1.25	54	86	8	10	6
150	38	196	165.2	204	202	1.25	1.25	58	95	8	10	6
200	42	248	216.3	256	254	1.25	1.25	64	102	8	10	6
250	48	306	267.4	314	312	1.25	1.25	72	118	10	12	6
300	52	360	318.5	370	366	1.25	1.25	78	127	10	15	6
350	54	402	355.6	412	406	1.25	1.25	84	134	12	15	6
400	60	456	406.4	468	462	1.25	1.25	92	149	15	20	7

Note (29) With IT flanges, this dimension is shown for reference.

Attached Table 10 Dimensional tolerance on flange

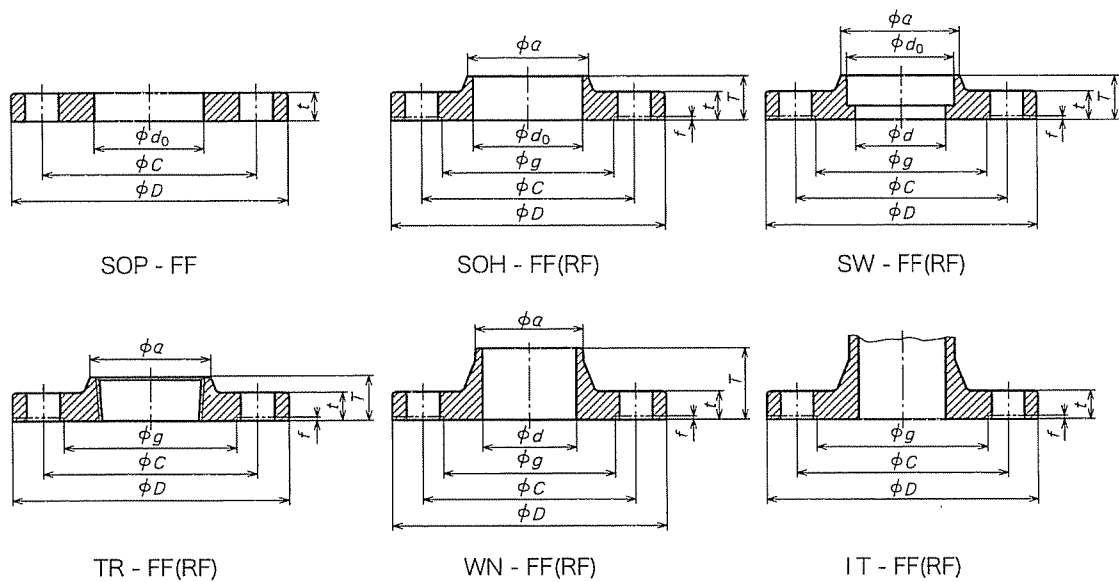

Unit : mm

Dimension	Type of flange	Gasket face	Dimensional division	Dimensional tolerance
Outside diameter of flange D	Except for IT	-	600 or less	± 1.5
			over 600	± 3
	IT	-	1,000 or less	Not specified for plus side values - 2
			Over 1,000	Not specified for plus side values - 3
Diameter of bolt centre circle C	ALL	-	950 or less	± 0.8
Pitch of bolt hole	ALL	-	Over 950	± 1.5
			-	± 0.8
Inside diameter d_0	SOP, SOH, SW, LJ	-	100 or less	+ 0.5 0
			Over 100 to and incl. 400	+ 1 0
			Over 400 to and incl. 600	+ 1.5 0
			Over 600 to and incl. 800	+ 2 0
			Over 800 to and incl. 1000	+ 2.5 0
			Over 1000	+ 3 0
Inside diameter d	SW, WN	-	100 or less	0 - 0.5
			over 100 to and incl. 400	0 - 1
			Over 400 to and incl. 600	0 - 1.5
			Over 600 to and incl. 800	0 - 2
			Over 800 to and incl. 1000	0 - 2.5
			Over 1000	0 - 3
Diameter of gasket face g	SOH, SW, TR, WN, IT, BL	RF, MF, TG	700 or less	± 0.8
			Over 700	± 1.5
Diameter of gasket face C_1, C_2, C_3, C_4	Except for LJ	MF, TG	500 or less	± 0.3
			over 500 to and incl. 1000	± 0.35
			Over 1000 to and incl. 1500	± 0.4
			Over 1500	± 0.5
Height of gasket face f_3, f_4	Except for LJ	MF, TG	-	± 0.2

Attached Table 10 (concluded)

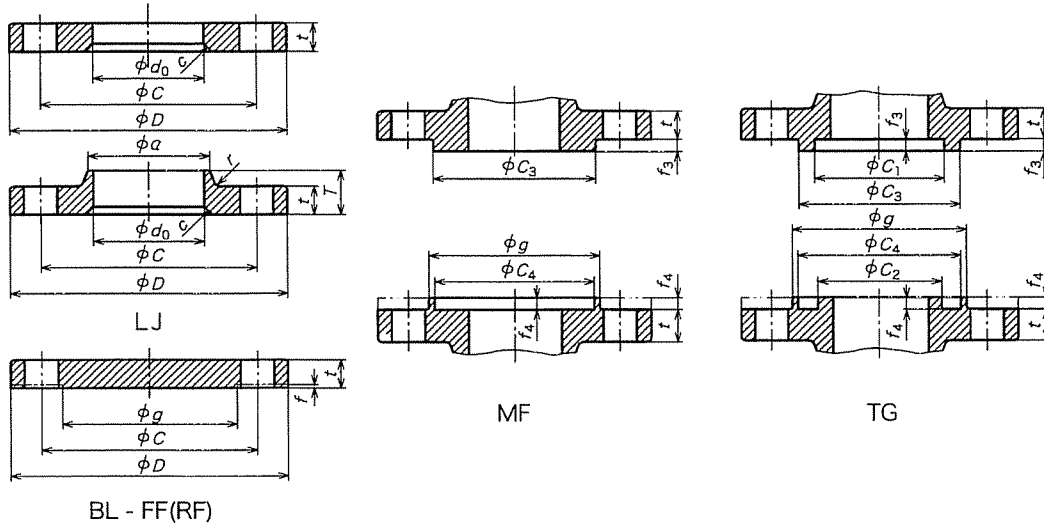

Unit : mm

Dimension	Type of flange	Gasket face	Dimensional division	Dimensional tolerance
Thickness of flange t ⁽³⁰⁾ t ⁽³¹⁾	Except for LJ	FF, MF, TG	20 or less	+1.5 0
			Over 20 to and incl. 50	+2 0
			Over 50	+3 0
	LJ	-	20 or less	+1.5 0
			Over 20 to and incl. 50	+2 0
			Over 50	+3 0
Thickness of flange $t-f$ ⁽³⁰⁾ t ⁽³¹⁾	SOH, SW, TR, WN, IT, BL	RF	20 or less	+1.5 0
			Over 20 to and incl. 50	+2 0
			Over 50	+3 0
Diameter of hub Small diameter side a	SOH, SW, LJ, TR, WN	-	220 or less	+2 0
			Over 220 to and incl. 650	+4 0
			Over 650	+8 0
Total length of flange T	SOH, SW, LJ, TR	-	-	± 2
	WN	-	200 or less	+2 0
Chamfering c	LJ	-	6 or less	+0.8 0
			Over 6	+1.6 0
Parallelism between gasket face and bolt nut bearing surface	Except for LJ	All	-	Within 1 degree

Notes ⁽³⁰⁾ The tolerance on thickness of integral flange (IT) of piping parts with which the dimension between flange facings is limited to a specific value may be set at twice the specified value.

⁽³¹⁾ For the spot facing of flanges, if they are so processed, the thickness is permitted in the minus side to 70 % of the tolerance on thickness of spot facing given in the table.

Annex 1 (normative)

Flanges processed by flash butt welding

1 Scope This annex 1(normative) specifies flanges processed by flash butt welding (hereafter referred to as “flange”).

With regard to matters as not specified in this annex, the provisions of the text shall be applied.

2 Definition For the purposes of this annex, the following definition apply.

weld portion portion of the flange where flash welding has been applied

3 Appearance The weld before removing the burr shall have smooth surface, and shall be free from such defects detrimental to practical use as misalignment of joint faces.

4 Liquid penetrant and magnetic particle inspection There shall be no cracks on the weld, and no die burn nor incomplete upset to affect the strength, using condition and the like.

5 Tensile strength The tensile strength of welds shall be greater than the minimum tensile strength required in the standard for the base metal. Tensile strength when the base metals are S20C or S25C of JIS G 4051 shall be determined by the agreement between the parties concerned.

6 Bending There shall be no defects of exceeding 3 mm in length on the surface of weld which has been bent.

7 Manufacturing method Flanges shall be manufactured from a steel sheet or steel strip by bending and flash welding. After the completion of the flash welding, stress relief annealing shall be applied at a temperature suitable for the material. For stainless steel, a solution treatment suitable for the material shall be applied.

8 Test methods Test on weld shall be as given in the following.

- a) **Liquid penetrant testing** Liquid penetrant testing shall be performed following the requirements of clause 8 of JIS Z 2343-1, by an appropriate test method.
- b) **Magnetic particle testing** The magnetic particle testing shall be performed, following the requirements of clause 8 of JIS G 0565, by an appropriate method.
- c) **Tensile test** For the tensile test, No.1 test piece or No.1A test piece defined in clause 3 of JIS Z 3121 shall be prepared to be tested as specified in JIS Z 2241.

The width of test piece (W) shall be 25 mm irrespective of the thickness (t) of the product.

- d) **Bending test** For the bending test, a bending test piece or a root bending test piece defined in clause 4 of JIS Z 3122 shall be prepared to be tested as specified in clause 5 of JIS Z 3122.

The thickness of the tested plate (T) shall be taken as it is as the thickness of the test piece (t). If the test is impossible due to less capacity of the tester, the plate shall be cut to divide into necessary thicknesses by using a thin saw, and the test may be carried out on each piece.

9 Process confirmation testing To ensure that the process of manufacturing is appropriate, the test piece shall be prepared and the tensile test and the bending test shall be performed prior to manufacturing. Tensile strength of welds shall be tested according to 8 c) and shall result in meeting the requirements of clause 5. The bending of welds shall be tested according to 8 d), and shall result in meeting the requirements of clause 6.

10 Inspection

10.1 Inspection of welds The inspection of welds shall be as given in the following.

- a) **Appearance** Appearance shall be inspected visually and shall meet the requirements of clause 3.
- b) **Liquid penetrant inspection** Liquid penetrant testing shall be performed according to 8 a) and the result shall meet the requirements of clause 4.
- c) **Magnetic particle inspection** Magnetic particle testing shall be performed according to 8 b), and the result shall meet the requirements of clause 4.

10.2 Acceptance inspection The acceptance inspection of the flange shall be performed, as required by the purchaser, for the following items. In this case, the sampling plan for lot inspection shall be in accordance with the agreement between the parties concerned.

- a) Appearance
- b) Liquid penetrant inspection
- c) Magnetic particle inspection

11 Marking On the periphery surface of the flange, symbol W shall be marked by such an indelible means as stamping, die marking, etching, and spraying after the symbols of material.

Example : 5K 300A SS 400 W

Annex 2 (informative)

Outside diameter of steel pipes

This annex 2 (informative) is to supplement the matters related to the text and the annex (normative), and not to constitute the provisions of this Standard.

Outside diameter of steel pipes with which flanges are joined are shown in annex 2 Table 1.

Annex 2 Table 1 Outside diameter of steel pipes

Number of standard	Nominal size	Outside diameter	Nominal size	Outside diameter
	A	mm	A	mm
JIS G 3452	10	17.3	350	355.6
JIS G 3454	15	21.7	400	406.4
JIS G 3455	20	27.2	450	457.2
JIS G 3456	25	34.0	500	508.0
JIS G 3457	32	42.7	550	558.8
JIS G 3458	40	48.6	600	609.6
JIS G 3459	50	60.5	650	660.4
JIS G 3468	65	76.3	700	711.2
	80	89.1	750	762.0
	90	101.6	800	812.8
	100	114.3	850	863.6
	125	139.8	900	914.4
	150	165.2	1 000	1 016.0
	175	190.7	1 100	1 117.6
	200	216.3	1 200	1 219.2
	225	241.8	1 350	1 371.6
	250	267.4	1 500	1 524.0
	300	318.5	—	—

Annex 3 (informative)

Standards of ASTM materials and ISO materials

This annex 3 (informative) is to supplement the matters related to the text and the annex (normative), and not to constitute the provisions of this Standard.

Material standard of ASTM and ISO shown in reference table 1 and reference table 2 of the text are as follows.

1 ASTM

ASTM A 105	<i>Carbon Steel Forgings for Piping Applications</i>
ASTM A 182	<i>Forged or Rolled Alloy-Steel Pipe Flanges, Forged Fittings, and Valves and Parts for High-Temperature Service</i>
ASTM A 204	<i>Pressure Vessel Plates, Alloy Steel, Molybdenum</i>
ASTM A 216	<i>Steel Castings, Carbon, Suitable for Fusion Welding, for High Temperature Service</i>
ASTM A 217	<i>Steel Castings, Martensitic Stainless and Alloy, for Pressure-Containing Parts, Suitable for High-Temperature Service</i>
ASTM A 240	<i>Heat-Resisting Chromium and Chromium-Nickel Stainless Steel Plate, Sheet, and Strip for Pressure Vessels</i>
ASTM A 350	<i>Carbon and Low-Alloy Steel Forgings, Requiring Notch Toughness Testing for Piping Components</i>
ASTM A 351	<i>Castings, Austenitic, Austenitic-Ferritic (Duplex), for Pressure-Containing Parts</i>
ASTM A 352	<i>Steel Castings, Ferritic and Martensitic, for Pressure-Containing Parts, Suitable for Low-Temperature Service</i>
ASTM A 387	<i>Pressure Vessel Plates, Alloy Steel, Chromium-Molybdenum</i>
ASTM A 515	<i>Pressure Vessel Plates, Carbon Steel, for Intermediate- and Higher-Temperature Service</i>
ASTM A 516	<i>Pressure Vessel Plates, Carbon Steel, for Moderate- and Lower-Temperature Service</i>

ASTM A 537 *Pressure Vessel Plates, Heat-Treated, Carbon-Manganese-Silicon Steel*

2 ISO

ISO 2604-1 : 1975 *Steel Products for pressure purposes—Quality requirements—Part 1 : Forgings*

ISO 4991 : — *Steel castings for pressure purposes (Draft standard just in 1992)*

ISO 9328-2 : 1991 *Steel plates and strips for pressure purposes—Technical delivery conditions—Part 2 : Unalloyed and low-alloyed steels with specified room temperature and elevated temperature properties*

ISO 9328-5 : 1991 *Steel plates and strips for pressure purposes—Technical delivery conditions—Part 5 : Austenitic steels*

Annex 4 (informative)

Small raised face

This annex 4 (informative) is to supplement the matters related to the text and the annex (normative), and not constitute the provisions of this Standard.

Annex 4 table 1 shows the dimension of the small raised face of gasket faces.

Annex 4 Table 1 Dimensions of small raised faces

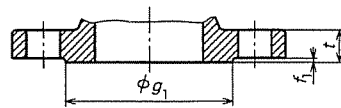

Unit : mm

Nominal size A	Small raised face	
	g_1	f
10	35	1
15	42	1
20	50	1
25	60	1
32	68	2
40	75	2
50	90	2
65	105	2
80	120	2
90	130	2
100	145	2
125	170	2
150	205	2
200	260	2
250	315	2
300	375	3
350	415	3
400	465	3

Remarks : The thickness of the flange t shall be as mentioned in attached tables 7 to 9, annex 6 table 3 and annex 6 table 4.

Annex 5 (informative)

Details of welded portion of welding flange

This annex 5 (informative) is to supplement the matters related to the text and the annex (normative), and not constitute the provisions of this Standard.

1 Details of welds of SOP and SOH flanges for nominal pressure 5K to 16K Details of welds of SOP and SOH flanges for nominal pressure 5K to 16K are shown in annex 5 figure 1.

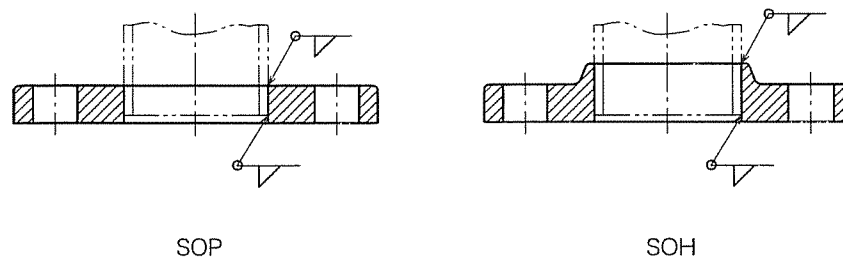

Remarks : The welding symbols are in accordance with JIS Z 3021.

Annex 5 Figure 1 Details of welds

2 Details of welds of SOH flange for nominal pressure 20K and 30K Details of welds of SOH flange for nominal pressure 20K and 30K are shown in annex 5 table 1 and annex 5 table 2, respectively.

Annex 5 Table 1 Details of welds of SOH flange for nominal pressure 20K

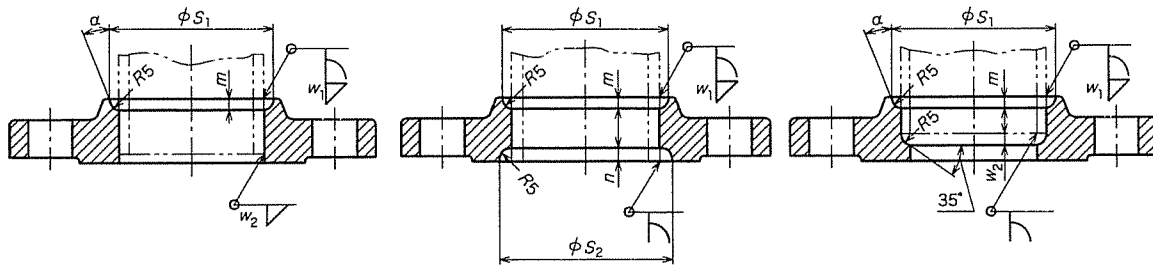
SOH type A of nominal size
10A to 600ASOH type B of nominal
size 10A to 50ASOH type C of nominal size
65A to 600A

Unit: mm

Nominal size A	S_1	S_2	m	n	α	Leg length of welds	
						w_1	w_2
10	27	27	4	4	—	4	3
15	31	31	4	4	—	4	3
20	37	37	4	4	—	5	3.5
25	44	44	4	4.5	—	6	4
32	52	53	4	5	—	6	4
40	58	59	4	5.5	—	6	4
50	70	72	4	5.5	—	6.5	4
65	94	—	6	—	20°	8	6
80	107	—	6	—	20°	8	6
90	120	—	6	—	20°	9	6
100	132	—	6	—	20°	9	7
125	160	—	7	—	30°	10	7
150	186	—	8	—	30°	10	8
200	237	—	9	—	30°	11	9
250	290	—	10	—	30°	12	10
300	345	—	11	—	30°	13	11
350	384	—	12	—	35°	14	12
400	437	—	13	—	35°	15	12
450	490	—	15	—	35°	16	14
500	544	—	16	—	35°	16	14
550	595	—	16	—	35°	18	16
600	646	—	18	—	35°	18	16

Remarks : The welding symbols are in accordance with JIS Z 3021.

Annex 5 Table 2 Details of welds of SOH flange for nominal pressure 30K

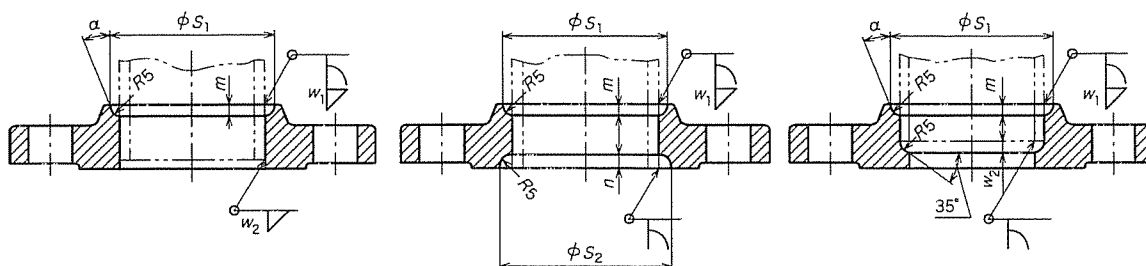
SOH type A of nominal size
10A to 400ASOH type B of nominal size
10A to 50ASOH type C of nominal size
65A to 400A

Unit: mm

Nominal size A	S_1	S_2	m	n	α	Leg length of welds	
						w_1	w_2
10	27	27	4	4	—	4	3
15	31	40	4	5	—	4	3
20	37	44	5	5	—	5	3.5
25	44	52	6	5	—	6	4
32	52	60	6	5	—	6	4
40	58	66	6	5	—	6	4
50	70	78	6.5	5	—	6.5	4
65	96	—	9.5	—	20°	10	6
80	109	—	9.5	—	20°	10	6
90	122	—	9.5	—	20°	10.5	6
100	135	—	9.5	—	20°	10.5	7
125	160	—	9.5	—	20°	10.5	7
150	186	—	9.5	—	20°	10.5	8
200	237	—	9.5	—	20°	11	9
250	290	—	10	—	20°	12	10
300	345	—	12	—	30°	13	11
350	383	—	13	—	30°	14	12
400	435	—	14	—	30°	15	13

Remarks : The welding symbols are in accordance with JIS Z 3021.

- 3 Detail of welds of SW flange Detail of welds of the SW flange is shown in annex 5 figure 2.

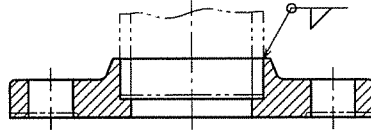

Remarks : The welding symbols are in accordance with JIS Z 3021.

Annex 5 Figure 2 Details of welds

- 4 Detail of welds of WN flange Detail of welds of the WN flange is shown in annex 5 figure 3.

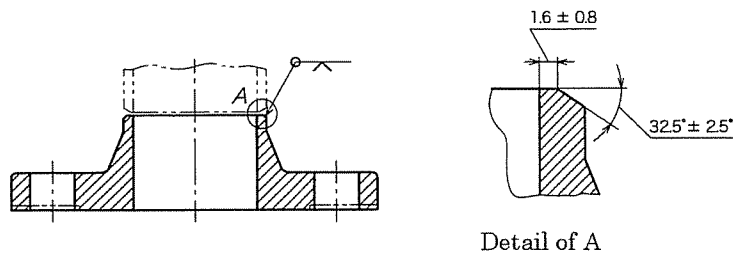

Remarks : The welding symbols are in accordance with JIS Z 3021.

Annex 5 Figure 3 Details of welds

Annex 6 (informative)

Flanges of nominal pressure 2K, 40K and 63K

This annex 6 (informative) is to supplement the matters related to the text and the annex (normative), and not constitute the provisions of this Standard.

1 Pressure-temperature rating Pressure-temperature rating for flanges for nominal pressure 2K, 40K and 63K is shown in annex 6 table 1.

Annex 6 Table 1 Pressure-temperature rating

Unit: MPa

Nominal size	Material group No.	Maximum working pressure										
		Fluid temperature °C										
		T_A to 120	220	300	350	400	425	450	475	490	500	510
2K	001, 002, 003a	0.3	0.2	–	–	–	–	–	–	–	–	–
40K	002, 003a	6.8	6.2	5.7	5.2	4.6 ⁽¹⁾	4.0 ⁽¹⁾	–	–	–	–	–
	013a	6.8	6.2	5.7	5.2	5.1	4.8	4.5	4.0	–	–	–
	015a	6.8	6.2	5.7	5.2	5.1	4.8	4.5	4.2	4.0	3.8	3.6
63K	002, 003a	10.7	9.7	9.0	8.1	7.2 ⁽¹⁾	6.3 ⁽¹⁾	–	–	–	–	–
	013a	10.7	9.7	9.0	8.1	8.0	7.6	7.1	6.3	–	–	–
	015a	10.7	9.7	9.0	8.1	8.0	7.6	7.1	6.6	6.3	5.9	5.6

Note ⁽¹⁾ Not to be applied to SC 480 of material group 002.

- Remarks
- 1 For the material group numbers, see table 5.
 - 2 T_A indicates the normal temperature.
 - 3 Maximum working pressure is at a temperature in the middle of the temperature shown in this table shall be obtained by the proportional interpolation method.

2 Basic size Basic size of flanges for nominal pressure 2K, 40K and 63K is shown in annex 6 tables 2 to 4, respectively.

Annex 6 Table 2 Basic dimension of flanges for nominal pressure 2K

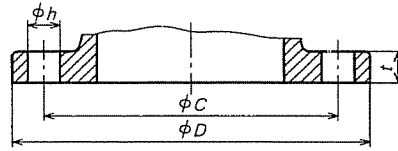

Unit: mm

Nominal size <i>A</i>	Joined dimension				Nominal designation of thread of bolt	Thickness of flange <i>t</i>
	Diameter of flange <i>D</i>	Diameter of bolt hole centre circle <i>C</i>	Diameter of bolt hole <i>h</i>	Number of bolts		
450	605	555	23	16	M20	22
500	655	605	23	20	M20	22
550	720	665	25	20	M22	24
600	770	715	25	20	M22	24
650	825	770	25	24	M22	24
700	875	820	25	24	M22	24
750	945	880	27	24	M24	24
800	995	930	27	24	M24	24
850	1 045	980	27	24	M24	24
900	1 095	1 030	27	24	M24	24
1 000	1 195	1 130	27	28	M24	26
1 100	1 305	1 240	27	28	M24	26
1 200	1 420	1 350	27	32	M24	26
1 350	1 575	1 505	27	32	M24	26
1 500	1 730	1 660	27	36	M24	28

Annex 6 Table 3 Basic dimension of flanges for nominal pressure 40K

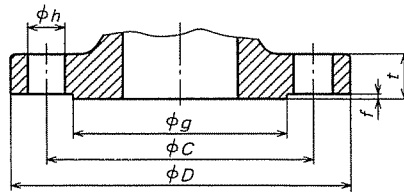

Unit: mm

Nominal size <i>A</i>	Joined dimension				Nominal designation of thread of bolt	Raised face		Thickness of flange <i>t</i>
	Diameter of flange <i>D</i>	Diameter of bolt hole centre circle <i>C</i>	Diameter of bolt hole <i>h</i>	Number of bolts		Diameter <i>g</i>	Height <i>f</i>	
10	110	75	19	4	M16	52	1	18
15	115	80	19	4	M16	55	1	20
20	120	85	19	4	M16	60	1	20
25	130	95	19	4	M16	70	1	22
32	140	105	19	4	M16	80	2	24
40	160	120	23	4	M20	90	2	24
50	165	130	19	8	M16	105	2	26
65	200	160	23	8	M20	130	2	30
80	210	170	23	8	M20	140	2	32
90	230	185	25	8	M22	150	2	34
100	250	205	25	8	M22	165	2	36
125	300	250	27	8	M24	200	2	40
150	355	295	33	12	M30 × 3	240	2	44
200	405	345	33	12	M30 × 3	290	2	50
250	475	410	33	12	M30 × 3	355	2	56
300	540	470	39	16	M36 × 3	410	3	60
350	585	515	39	16	M36 × 3	455	3	64
400	645	570	39	16	M36 × 3	515	3	70

Annex 6 Table 4 Basic dimension of flanges for nominal pressure 63K

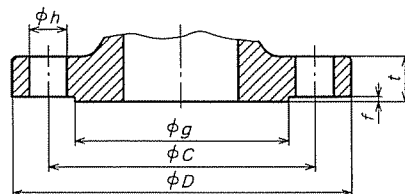

Unit: mm

Nominal size	Joined dimension					Raised face		Thick-ness of flange
	Diameter of flange	Diameter of bolt hole centre circle	Diameter of bolt hole	Number of bolts	Nominal designa-tion of thread of bolt	Diameter	Height	
<i>A</i>	<i>D</i>	<i>C</i>	<i>h</i>			<i>g</i>	<i>f</i>	<i>t</i>
10	115	80	19	4	M16	52	1	23
15	120	85	19	4	M16	55	1	23
20	135	95	23	4	M20	60	1	25
25	140	100	23	4	M20	70	1	27
32	150	110	23	4	M20	80	2	30
40	175	130	25	4	M22	90	2	32
50	185	145	23	8	M20	105	2	34
65	220	175	25	8	M22	130	2	38
80	230	185	25	8	M22	140	2	40
90	255	205	27	8	M24	150	2	42
100	270	220	27	8	M24	165	2	44
125	325	265	33	8	M30 × 3	200	2	50
150	365	305	33	12	M30 × 3	240	2	54
200	425	360	33	12	M30 × 3	290	2	60
250	500	430	39	12	M36 × 3	355	2	68
300	560	485	39	16	M36 × 3	410	3	77
350	615	530	46	16	M42 × 3	455	3	81
400	680	590	46	16	M42 × 3	515	3	89

Annex 7 (informative)

Calculated mass of flanges

This annex 7 (informative) is to supplement the matters related to the text and the annex (normative), and not to constitute the provisions of this Standard.

Calculated mass of flanges based on their nominal pressure, type (excluding IT flange) and nominal size is shown in annex 7 table 1.

Annex 7 Table 1 Mass of flanges

Unit : kg

Nominal size	Nominal pressure																	
	5K								10K								10K light type	
	SOP	SOH	SW	LJ	TR	WN		BL	SOP	SOH	SW	LJ	TR	WN		BL	SOP	SOH
A						H								H				
10	0.26	--	0.27	--	0.28	0.30	--	0.28	0.51	--	0.52	--	0.52	0.55	--	0.53	0.42	--
15	0.30	--	0.31	0.29	0.31	0.35	--	0.32	0.56	--	0.58	0.56	0.58	0.63	--	0.60	0.45	--
20	0.36	--	0.38	0.36	0.39	0.44	--	0.41	0.72	--	0.75	0.71	0.75	0.80	--	0.79	0.54	--
25	0.45	--	0.48	0.44	0.50	0.56	--	0.52	1.12	--	1.16	1.11	1.17	1.26	--	1.22	1.00	--
32	0.77	--	0.83	0.76	0.84	0.94	--	0.91	1.47	--	1.53	1.45	1.54	1.67	--	1.66	1.14	--
40	0.82	--	0.90	0.80	0.91	1.03	--	1.00	1.55	--	1.65	1.53	1.65	1.78	--	1.79	1.20	--
50	1.06	--	1.19	1.03	1.20	1.33	--	1.38	1.86	--	1.97	1.83	1.99	2.18	--	2.23	1.68	--
65	1.48	--	1.72	1.44	1.74	1.92	--	2.00	2.58	--	2.77	2.53	2.79	3.07	--	3.24	2.05	--
80	1.97	--	2.34	1.92	2.35	2.53	--	2.67	2.58	--	2.89	2.52	2.90	3.17	--	3.48	2.10	--
90	2.08	--	--	2.02	--	2.70	--	2.99	2.73	--	--	2.66	--	3.40	--	3.90	2.21	--
100	2.35	--	--	2.28	2.99	3.04	--	3.66	3.10	--	--	3.02	3.70	3.89	--	4.57	2.86	--
125	3.20	--	--	3.08	4.29	4.17	--	5.16	4.73	--	--	4.60	5.70	5.77	--	7.18	4.40	--
150	4.39	--	--	4.25	5.74	5.87	--	7.47	6.30	--	--	6.14	7.48	7.86	--	10.1	5.30	--
175	5.42	--	--	--	--	7.16	--	9.52	6.75	--	--	--	--	8.70	--	11.8	6.39	--
200	6.24	--	--	6.06	--	8.50	--	12.1	7.46	--	--	7.28	--	10.1	--	13.9	7.04	--
225	6.57	--	--	--	--	9.30	--	13.9	7.70	--	--	--	--	10.6	--	15.8	7.35	--
250	9.39	--	--	9.11	--	13.2	--	19.2	11.8	12.7	--	12.3	--	16.0	--	22.6	11.1	--
300	10.2	--	--	9.76	--	15.1	--	24.2	12.6	13.8	--	13.2	--	18.1	--	27.8	12.0	--
350	14.0	--	--	13.4	--	21.6	--	33.0	16.3	18.2	--	17.4	--	24.8	--	36.9	14.2	--
400	16.9	--	--	16.2	--	26.2	--	41.7	23.2	25.8	--	24.8	--	34.2	--	52.1	--	22.1
450	21.4	24.9	--	23.9	--	32.7	--	52.7	29.3	33.4	--	32.3	--	42.7	--	68.4	--	--
500	23.0	27.0	--	25.6	--	35.4	--	61.6	33.3	38.0	--	36.4	--	50.3	60.4	81.6	--	--
550	30.1	34.5	--	33.0	--	44.4	--	80.8	42.9	49.4	--	47.7	--	64.4	76.7	112	--	--
600	32.5	37.8	--	36.2	--	47.8	--	92.7	45.4	52.6	--	50.8	--	69.1	82.1	134	--	--
650	35.6	43.2	--	--	--	54.3	--	114	51.8	60.2	--	--	--	78.7	92.6	161	--	--
700	38.0	45.8	--	--	--	60.6	74.0	138	59.0	70.2	--	--	--	94.5	129	196	--	--
750	48.4	57.7	--	--	--	75.4	91.1	171	72.8	86.5	--	--	--	114	158	248	--	--
800	51.2	61.3	--	--	--	79.5	96.3	202	76.0	92.0	--	--	--	120	166	286	--	--
850	53.9	65.3	--	--	--	87.0	105	237	80.1	98.7	--	--	--	126	175	330	--	--
900	60.7	73.1	--	--	--	95.2	114	260	88.9	110	--	--	--	138	190	377	--	--
1 000	70.1	84.8	--	--	--	111	147	345	109	133	--	--	--	171	236	512	--	--
1 100	81.6	105	--	--	--	146	202	454	131	175	--	--	--	222	307	675	--	--
1 200	101	129	--	--	--	190	265	586	163	215	--	--	--	275	381	854	--	--
1 350	116	151	--	--	--	240	324	814	204	274	--	--	--	368	496	1180	--	--
1 500	137	180	--	--	--	284	385	1060	248	340	--	--	--	459	624	1590	--	--

- Remarks 1 Values of the mass are calculated on an evaluation for density of steel at 7.85 g/cm³.
- 2 Calculation is aimed at obtaining the mass of full face (FF) flange.
- 3 The symbol H shows WN flanges with substitutional dimension. See attached table 4 and attached table 5.

Annex 7 Table 1 (concluded)

Unit: kg

Nominal size	Nominal pressure																		
	16K						20K						30K						
	SOH	SW	LJ	TR	WN	BL	SOH			SW	LJ	TR	WN	BL	SOH			WN	BL
							A	B	C						A	B	C		
10	0.52	0.53	—	0.53	0.56	0.53	0.58	0.58	—	0.60	—	0.60	0.61	0.59	1.00	1.00	—	—	1.00
15	0.58	0.58	0.57	0.59	0.64	0.60	0.65	0.64	—	0.67	0.68	0.67	0.70	0.67	1.24	1.22	—	1.33	1.25
20	0.75	0.76	0.74	0.77	0.81	0.79	0.81	0.80	—	0.84	0.84	0.84	0.88	0.86	1.36	1.34	—	1.45	1.38
25	1.16	1.18	1.15	1.19	1.27	1.22	1.27	1.26	—	1.31	1.33	1.32	1.37	1.34	1.77	1.75	—	1.92	1.84
32	1.53	1.56	1.50	1.57	1.67	1.66	1.58	1.57	—	1.64	1.70	1.64	1.73	1.73	2.17	2.15	—	2.39	2.32
40	1.64	1.68	1.61	1.69	1.79	1.79	1.68	1.66	—	1.74	1.80	1.74	1.85	1.87	2.82	2.79	—	3.09	3.00
50	1.83	1.88	1.79	1.90	2.05	2.09	1.89	1.86	—	1.96	2.00	1.97	2.12	2.20	2.89	2.86	—	3.24	3.14
65	2.58	2.68	2.51	2.71	3.00	3.08	2.73	—	2.81	2.92	2.89	2.91	3.11	3.24	4.88	—	4.96	5.70	5.50
80	3.61	3.76	3.53	3.81	4.16	4.41	3.85	—	3.95	4.13	4.04	4.08	4.30	4.63	5.70	—	5.80	6.72	6.63
90	3.89	—	3.80	—	4.53	4.92	4.47	—	4.59	—	4.67	—	5.08	5.67	7.13	—	7.25	8.32	8.55
100	4.87	—	4.76	5.18	5.76	6.29	5.03	—	5.18	—	5.24	5.35	5.95	6.61	8.01	—	8.16	9.41	10.0
125	7.09	—	6.92	7.76	8.39	9.21	7.94	—	8.15	—	8.24	8.44	9.31	10.5	11.6	—	11.9	14.0	15.3
150	9.57	—	9.35	10.2	11.5	12.7	10.4	—	10.7	—	10.8	11.1	12.6	14.4	17.0	—	17.3	20.3	22.2
200	12.0	—	11.8	—	15.3	18.4	13.1	—	13.6	—	13.6	—	16.6	20.8	22.2	—	22.6	27.2	32.6
250	20.1	—	19.6	—	24.8	30.4	23.1	—	23.8	—	23.7	—	28.3	36.2	36.8	—	37.5	45.3	55.2
300	24.3	—	23.6	—	31.3	40.5	27.2	—	28.1	—	28.1	—	34.9	47.4	49.1	—	50.0	61.0	77.9
350	34.4	—	33.5	—	45.7	57.5	38.4	—	39.5	—	39.7	—	50.2	66.1	60.4	—	61.5	74.6	96.9
400	47.4	—	46.3	—	63.6	81.7	53.9	—	55.5	—	55.6	—	71.7	97.0	82.0	—	83.7	103	136
450	61.8	—	60.5	—	82.8	107	71.0	—	72.9	—	73.1	—	92.8	126	—	—	—	—	—
500	73.7	—	71.7	—	96.3	132	84.6	—	86.7	—	86.5	—	108	155	—	—	—	—	—
550	87.9	—	85.8	—	116	163	102	—	104	—	104	—	128	190	—	—	—	—	—
600	98.4	—	96.1	—	130	192	115	—	117	—	117	—	144	231	—	—	—	—	—

Remarks 1 Values of the mass are calculated on an evaluation for density of steel at 7.85 g/cm³.

4 For flanges for nominal pressure 16 K, the calculation is aimed at obtaining the mass of a full face (FF) flange, and for nominal pressure 20 K and 30 K, the mass of raised face (RF) flange.

5 Symbols A, B and C indicates type A, type B and type C of SOH flange, respectively. See attached table 8 and attached table 9.

Related standard : JIS B 2001 Nominal size and bore of valves

Annex 8 (informative)

Comparison table between JIS and corresponding International Standard

JIS B 2220 : 2004 <i>Steel pipe flanges</i>		ISO 7005-1 : 1992 <i>Metallic flanges—Part 1: Steel flanges</i>		(V) Justification for the technical deviation between JIS and International Standard and future measures
(I) Requirements in JIS	(II) International Standard number	(III) Requirements in International Standard	(IV) Classification and details of technical deviation between JIS and International Standard by clause Location of deviation: text	
Clause	Contents	Clause	Contents	Detail of technical deviation
1 Scope	This Standard specifies steel pipe flanges ranging from nominal size of 10A to 1500A, nominal pressures of 5K, 10K, and 16K, of light type, 20K, and 30K to be jointed with piping parts such as steel pipes and valves used in pipes for ordinary piping, pressure services, high-pressure services, high temperature services, and alloy steel pipings and stainless pipings for steam, air, gas, water, and oil, and so forth.	ISO 7005-1	1.1 Scope This Standard specifies PN nominal pressure steel round flanges shown in the following: Series*: N10, PN16, PN20, PN50, PN110, PN150, PN260, PN420 Series: 2*: PN2,5, PN6, PN25, PN40 Note*: The flanges of the Series 1 are basic. The flanges of Series 2 will become limited use in the future. Classification of steel flanges, gasket faces, dimension, and dimensional tolerance, screws and normal bolt size, finishing of gasket face, marking, tests, and inspection shall be specified. Neither the pressure-temperature rating nor material of steel flanges shall be specified.	As the international trend, Europe arranges an amendment draft based on the EN Standards, while the United States, based on ASME. In Japan, on the other hand, this standard has been prepared as a Japanese draft through integrating the current JIS B 2220 Steel welding pipe flange and the JIS B 2238 steel flanges general rules. This standard is translated into English immediately for submission as an amendment draft. It is so expected that the International Standards will be divided respectively by a part system: - 1 (EN), - 2 (ASME), and - 3 (JIS).
2 Normative references		1.2 Normative references		
3 Definitions		1.3 Definitions		
4 Classification of flanges and their designations		2 General requirements		
5 Classification of gasket faces and their designations		2.2 Material and bolting		

(I) Requirements in JIS		(II) International Standard number	(III) Requirements in International Standard		(IV) Classification and detail of technical deviation between JIS and International Standard by clause and their contents Location of deviation: text		(V) Justification for the technical deviation between JIS and International Standard and future measures
Clause	Contents		Clause	Contents	Classification by clause	Detail of technical deviation	
6 Designation of flanges according to zinc coating			2.3 Repairs 2.4 Dimensions 2.5 Facing 2.6 Spot-facing or back-facing	This specification shall be applied neither to flanges that are processed by turning from bar stocks, nor to classifications manufactured from steel plate material, such as 11, 12, 13, 14, and 15 type flanges. No classification, inension, design characteristics, nor material of gasket shall be specified.			
7 Materials			2.7 Tolerances 2.8 Marking 2.9 Inspection and test				
8 Relationship between fluid temperature and maximum working pressure			2.10 Information to be supplied by the purchaser				
9 Nominal size of flange application of pressure-temperature rating							
10 Dimensions							
11 Appearance							
12 Surface finish							
13 Soundness							
14 Zinc coating							
15 Manufacturing method							
16 Test methods							
17 Inspection							
18 Designation							
19 Marking							

Comprehensive evaluation of the degree of correspondence of JIS to International Standard : NEQ

Remarks 1 Meaning of symbols of the evaluation column of each item shall be as follows.

- NEQ : Technical difference are present, and none of those have been clearly identified and explained.
- 2 The meaning of the symbols in the comprehensive evaluation column concerning the degree of the correspondence of JIS to the International Standard is as follows.
 - NEQ : JIS is not equal to the International Standard in terms of technical contents and structure.

(

.

l

(

(

v

6

o

(

Errata for JIS (English edition) are printed in *Standardization Journal*, published monthly by the Japanese Standards Association, and also provided to subscribers of JIS (English edition) in *Monthly Information*.

Errata will be provided upon request, please contact:
Standardization Promotion Department, Japanese Standards Association
4-1-24, Akasaka, Minato-ku, Tokyo, 107-8440 JAPAN
TEL. 03-3583-8002 FAX. 03-3583-0462

100% Recycled paper

